



Receiver
Ampli-Tuner Hi-Fi

R-N600A

EN Quick Guide
FR Guide rapide

Contents

Introduction.....	2
Checking the accessories	2
Connecting speakers.....	3
Flipping up the wireless antenna.....	4
Connecting to an outlet	4
Turning the power ON	5
Connecting to the network.....	6
Playing Internet radio	7

Table des matières

Introduction.....	8
Vérification des accessoires.....	8
Raccordement des enceintes.....	9
Comment relever l'antenne sans fil	10
Branchement sur une prise de courant ...	10
Mise sous tension	11
Connexion au réseau.....	12
Lecture de la radio sur Internet.....	13

Introduction

Thank you very much for purchasing this Yamaha product.

This product is a network-compatible receiver for home use. It can play radio broadcasts and network content, as well as analog and digital audio input.

About the guides

Please be sure to read the following guides. Keep the guides that are included with the product in a handy place for easy reference.

■ Safety Guide (included with the product)

Lists important safety precautions that should be read prior to use.

■ Quick Guide (this guide)

Explains basic connections, playback of Internet radio, and more.

■ User Guide (Website)

Explains all functions. To view, access the URL at right. Please note that the User Guide is provided only on the website.



<https://manual.yamaha.com/av/22/rn600a/>

About the symbols used in the Quick Guide

- "NOTICE" is used with information for preventing product failure, damage or malfunction, and/or loss of data.
- "NOTE" is used with supplementary information that is helpful to know.

Checking the accessories

Check and make sure that you have all the following items.

- **AM Antenna***
(Models for U.S.A., Canada, China, Korea, Asia, Taiwan, and for Central and South America)



- **FM antenna***
(Models for U.S.A., Canada, China, Korea, Asia, Taiwan, and for Central and South America)



One of the above is supplied depending on the region of purchase.

- **DAB/FM antenna***
(Models for U.K., Europe, Russia and Australia)



- **Remote control***



- **Batteries* (AA, R6, UM-3) (x2)**
- **Safety Guide**
- **Quick Guide (this guide)**

Items marked with * are not explained in this guide. See the User Guide for more information.

Have the following equipment on hand, in addition to the product.

- Speakers (x2)
- Speaker cables (x2)
- Subwoofer* (built-in amp)
- Monaural pin cable* (RCA)
- Wireless router
- Smartphone or other mobile device

Items marked with * are not required in some cases. Have them ready if needed.

Connecting speakers

Connect the speakers as illustrated. Connect a subwoofer if needed.

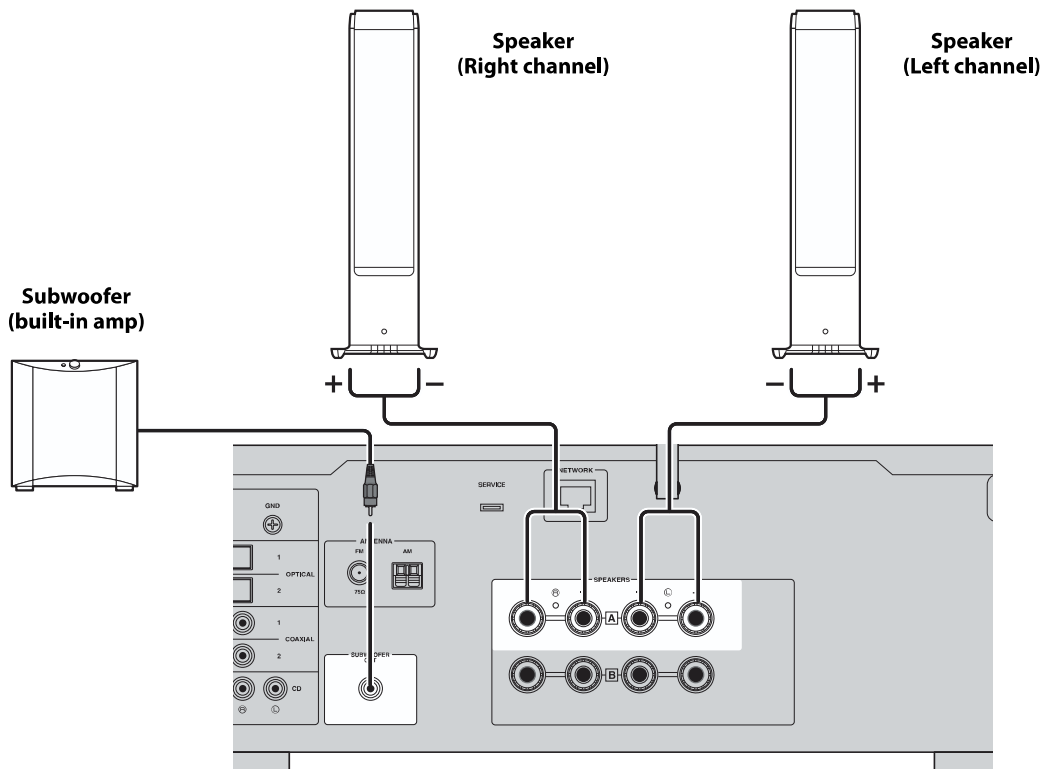

1 Peel off about 10 mm of insulation on the end of the speaker cable and twist its core tightly.

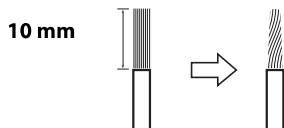

NOTE

- Use speakers with an impedance of at least 4-ohm.
- If using 4-ohm speakers (or more than 4-ohm but less than 8-ohm), change the impedance settings of this product. These settings can be changed in the product's Advanced Setup menu. See the User Guide for details.

2 Turn the knob of the speaker jack to the left to loosen it, then insert the core of the speaker cable into the hole in the jack.

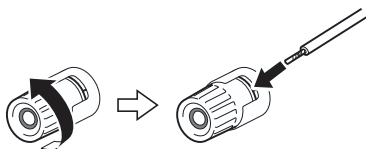

NOTICE

Do not allow the core wires of a speaker cable to touch the core wires of another speaker cable or any metal parts of the product. Doing so may damage the product and/or the speakers.

3 Turn the knob back to the right to tighten it.



Flipping up the wireless antenna

Flip up the wireless antenna as illustrated.

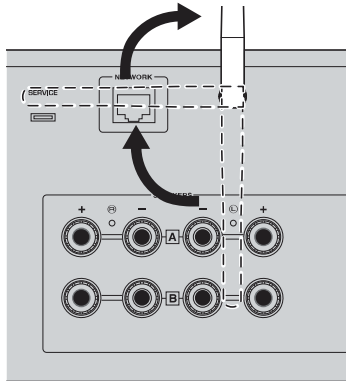

NOTICE

At the time of purchase, the wireless antenna is held in place with tape. Gently peel off the tape, then flip up the wireless antenna as shown in the illustration. Do not exert excessive force on the wireless antenna. Doing so may damage it.

Connecting to an outlet

Connect the power cord to an outlet.

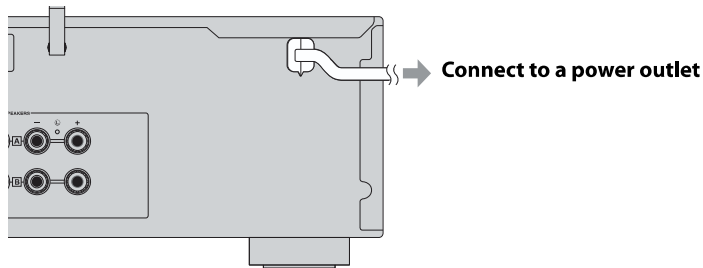

Turning the power ON

Turn the product ON.

- 1 Press the  (Power) Switch to turn the power ON.**
The power indicator lights up.

Power Indicator
 (Power) Switch

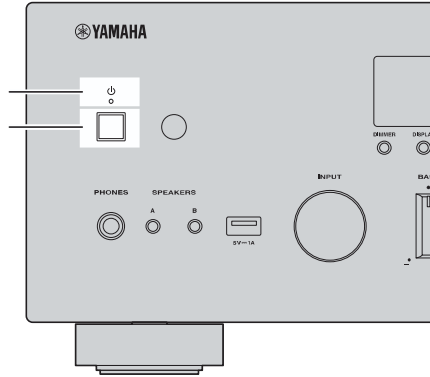

- 2 After the following message is displayed on the front display, press RETURN on the front panel to eliminate the message.**

It may take about 30 seconds for the message to be shown. The portion marked with "*" varies depending on the device.

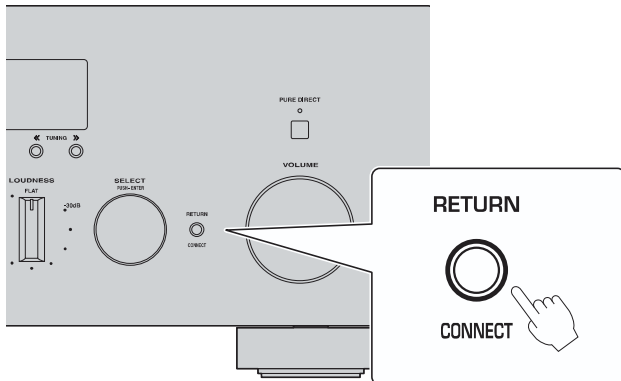

"WAC" Display

The WAC (Wireless Accessory Configuration) function is for applying the wireless settings of an iOS device to another device and wirelessly connecting to the network. Because it is explained on a later page how to connect to networks with the MusicCast Controller app, how to cancel WAC is explained here.

Connecting to the network

After installing the “MusicCast Controller” app for mobile devices, connect the product wirelessly to your network from the app screen.

1 Prepare a mobile device.

Refer to the Wi-Fi settings on your mobile device and make sure you are connected to the wireless router’s network.

2 Install “MusicCast Controller” on the mobile device.

Search for “MusicCast Controller” on the App Store or Google Play to download the app.

3 Start the app and start configuring settings as directed by the app.

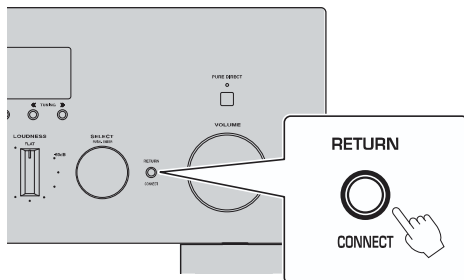
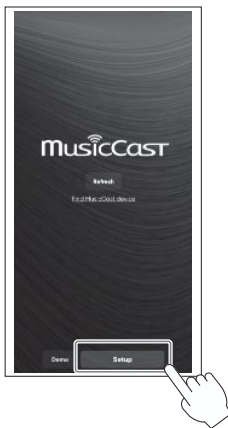

Following the app’s guide, press
CONNECT for 5 seconds or longer.

Important Notice about Information Security

For details, go to the URL at right.



<https://manual.yamaha.com/av/policy/mcc/>

NOTE

- You can also connect to the network via a wired connection. See the User Guide for details.
- If you want to cancel the configuration before it is complete, press RETURN on the front panel.
- If the connection fails, quit the app, and then try again from Step 3.

Playing Internet radio

Use the app to confirm that you can play Internet radio.

- 1 On the app's screen, select the room that is registered to this product, and select "Net Radio" as the source to play.**

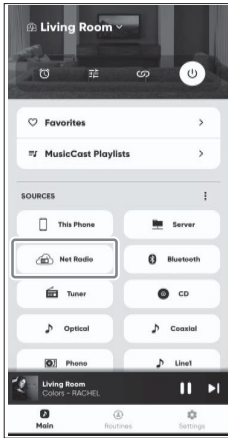

If you are connected to the Internet, a list of Internet radio stations appears. If it does not appear, reconnect to the Internet.

- 2 Choose the desired station.**
Choose the desired station from the list of Internet radio stations.

- 3 Adjust the volume.**
Adjust with the volume slider in the app. You can also adjust it with VOLUME on the front panel.

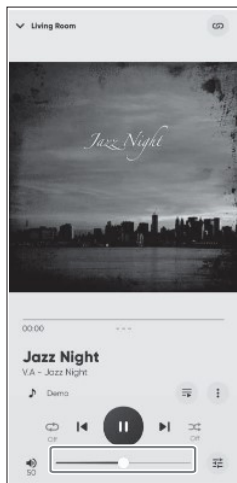

This completes the initial setup.

For other detailed instructions on connections and settings, refer to the User Guide.