

INVISILED® PRO

24V LED Tape Light

WAC



Tape Section



3 LED "L" Connector

Fixture Type:

Catalog Number:

Project:

Location:

PRODUCT DESCRIPTION

Professional grade white tape light that delivers optimal color consistency and brightness. An ideal dimmable system for task or accent lighting application in residential, hospitality and commercial environments.

FEATURES

- Can be field cut, male to male adapter required to re-use female side
- Ultra thin profile at 3/8"
- Diodes spaced evenly at 1" on center
- Minimum run length of 1'
- May be field cut every 2" at the end of a run
- Three mounting methods provided for different surfaces
- Specially rated for installation in the storage area of a clothes closet
- 50,000 hour rated life
- 5 year WAC Lighting product warranty

SPECIFICATIONS

- Construction:** Flexible silicone-cased tape light, peel-and-stick 3M construction adhesive, indicating marks on back for field cutting
- Light Source:** 12 LEDs per foot, Runs on 24V at 3W per foot
- Operating Temp:** -4°F – 122°F (-20°C – 50°C), relative humidity 95%
- Standards:** UL & cUL Listed for Damp Locations

ORDER NUMBER – TAPE SECTION

| Model | Watts/ft | Color Temp | CRI | Lumens/ft | Length | Qty | Tape Color |
|------------------|-----------|------------|-----|-----------|---------------|-----------|------------|
| LED-T24 3 | W | 2700K | 85 | 200 | 2IN | 2 inches | 1 |
| | P | 3000K | 85 | 200 | 2IN-10 | 2 inches | 10 |
| | 35 | 3500K | 85 | 207 | 1 | 1 foot | 1 |
| | C | 4500K | 85 | 215 | 1-40 | 1 foot | 40 |
| | | | | | 5 | 5 feet | 1 |
| | | | | | | WT | White |

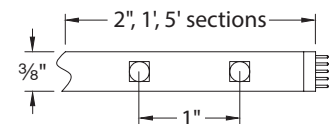

LED-T24__ - __-WT

Example: **LED-T24P-2IN-10-WT**

ORDER NUMBER – 3 LED "L" CONNECTOR

| Model | Watts/ft | Color Temp | CRI | Lumens/ft | Tape Color |
|--------------------|-----------|------------|-----|-----------|--------------|
| LED-T24 1.2 | W | 2700K | 85 | 50 | 3L-WT |
| | P | 3000K | 85 | 50 | |
| | 35 | 3500K | 85 | 52 | |
| | C | 4500K | 85 | 54 | |
| | | | | | White |

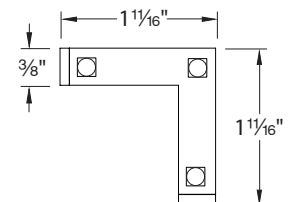

LED-T24__ -3L-WT

Example: **LED-T24C-3L-WT**

wacighting.com

Phone (800) 526.2588

Fax (800) 526.2585

Headquarters, East Manufacturing Facility

44 Harbor Park Drive

Port Washington, NY 11050

South East Manufacturing Facility

1600 Distribution Ct

Lithia Springs, GA 30122

Central Manufacturing Facility

1700 South J Elmer Freeway, Ste 100

Cedar Hill, TX 75104

West Manufacturing Facility

1750 S Archibald Ave



Ontario, CA 91761

INVISILED® PRO

24V LED Tape Light

WAC

CLASS 2 POWER SUPPLY (REQUIRED)

| Model | | Input | Output | Max Run | Dimming | Description |
|--|--|---------------------------------|------------------|----------------------------|-------------------|---|
|  | EN-2460-RB2-T EN-24100-RB2-T | <i>Remote</i> | 120VAC 120VAC | 24VAC / 60W 24VAC / 96W | 20' 33' | 100%-5% ELV UL Class 2 output. |
|  | PS-24DC-U60R-T PS-24DC-U96R-T | <i>Remote</i> | 120-277VAC | 24VDC / 60W 24VDC / 96W | 20' 33' | 100%-5% ELV, TRIAC Includes a 6' lead wire. UL Class 2 output. |
|  | PS-24DC-U3X96R-T | <i>Remote</i> | 120-277VAC | 24VDC / 3 X 96W | 33' per output | 100%-5% ELV, TRIAC, 0-10V Includes a 6' lead wire. Overload and short circuit protection. |
|  | EN-24100-277-RB2-T | <i>Remote</i> | 277VAC | 24VDC / 96W | 33' | 100%-5% 0-10V Includes a 6' lead wire. UL Class 2 output. |
|  | EN-2460-P-AR-T EN-24100-P-AR-T | <i>Plug-in</i> | 120VAC 120VAC | 24VAC / 60W 24VAC / 96W | 20' 33' | Non Dimmable Includes a 6' lead wire. UL Class 2 output. |
|  | EN-D24100-120-R | <i>Wall Dimmer + Driver</i> | 120VAC | 24VDC / 96W | 33' | <i>Integral</i> • UL Class 2 Output |
|  | EN-D24060-120-R EN-D24096-120-R | <i>Wall Dimmer + Driver</i> | 120VAC | 24VDC / 60W 24VDC / 96W | 20' 33' | <i>Integral</i> • LED Driver & In-Wall Dimmer Switch in one unit, fits in a standard recessed electrical box. • Adjustable voltage output dial to address voltage drop. • White face plate only (nonexchangeable). |

wacighting.com

Phone (800) 526.2588
Fax (800) 526.2585

Headquarters, East Manufacturing Facility
44 Harbor Park Drive
Port Washington, NY 11050

South East Manufacturing Facility
1600 Distribution Ct
Lithia Springs, GA 30122

Central Manufacturing Facility
1700 South J Elmer Freeway, Ste 100
Cedar Hill, TX 75104



West Manufacturing Facility
1750 S Archibald Ave
Ontario, CA 91761

INVISILED® PRO



24V LED Tape Light



CONTROLLER

| MODEL | Input | Output | Dimension |
|--|--------------|--------|---|
|  CT-6A-R2 | 12/24 VAC/DC | | Touch Panel and Motion Sensor Includes a Touch Panel, Occupancy Sensor and a Controller. AC/DC input at 24V(96W Max). Connect on secondary side of power supply |
|  IR-96-24VACDC-WT IR-96-24VACDC-BK | 24 VAC/DC | | IR Sensor IR (Infrared sensors switch works by turning the lights on when it becomes unobstructed). |

SMART CONTROLLER

| MODEL | Input | Output | Dimension |
|---|------------|--------|--|
|  LED-WCT-WT | 120-230VAC | N/A | WallStation - Multi-scene selection - Raise/Lower, dedicated Off button - Suitable for standard single NEMA wall box Setup and configuration via MyWAC mobile application - no physical adjustment needed - cUL listed |
|  CT-96-SM | | | InvisiLED® Smart Home Kit Transform your interiors with the InvisiLED® Smart Home Kit, designed exclusively for InvisiLED Lite+, Pro+, Pro2+ and Pro 3 Tape. Control your LED tape seamlessly via Wi-Fi using the MyWAC app with devices you already own, including Amazon Alexa and Google Home. Offers on/off activation and up/down dimming capability for 24VDC systems and high-output tape lighting applications. Or use DMX to control your popular control platforms. Includes a 96W 24VDC Power Supply (EN-24DC096-UNV-RB2), wireless controller (CTR-WDMX-24VDC) and a ready-to-connect lead wire with an InvisiLED Connector (LED-TC-B-2-WT) |

EXAMPLE INSTALLATION FOR WIRELESS AND DMX CONTROL

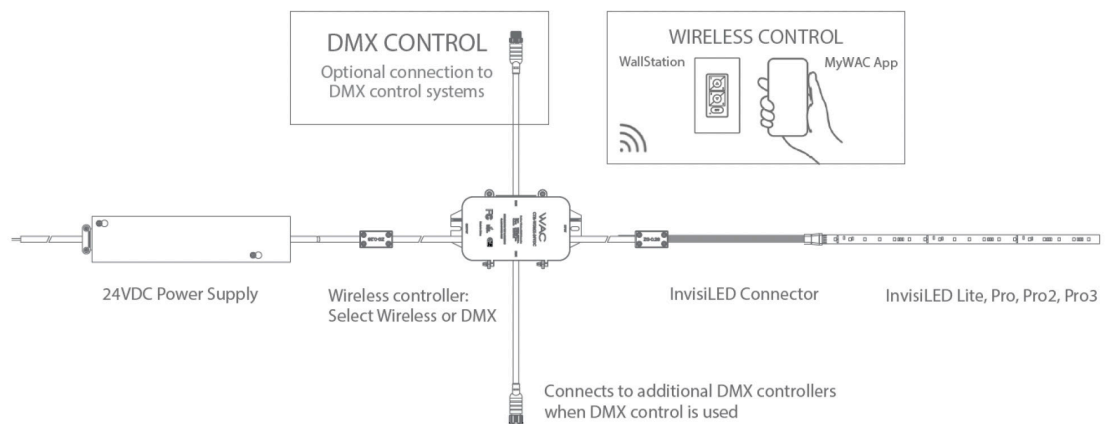

wacighting.com
 Phone (800) 526.2588
 Fax (800) 526.2585

Headquarters, East Manufacturing Facility
 44 Harbor Park Drive
 Port Washington, NY 11050

South East Manufacturing Facility
 1600 Distribution Ct
 Lithia Springs, GA 30122

Central Manufacturing Facility
 1700 South J Elmer Freeway, Ste 100
 Cedar Hill, TX 75104

West Manufacturing Facility
 1750 S Archibald Ave
 Ontario, CA 91761

INDOOR ELECTRICAL ACCESSORIES

| | Model | Dimension | Finish | Description |
|---|--------------------|----------------------------|--------|---|
|  | LED-TC-WEXT-144 | 12' | Black | In Wall Rated Extension Cable Extends distance between a hard wired power supply or a wiring box to a tape section. |
| | LED-TC-WEXT-144-WT | 12' | White | |
| | LED-TC-WEXT-240 | 20' | Black | |
| | LED-TC-WEXT-240-WT | 20' | White | |
|  | LED-TC-WIC-144 | 12' | Black | In Wall Rated Joiner Cable Connects tape sections. 2 female ends. 1 male to male connector included. |
| | LED-TC-WIC-144-WT | 12' | White | |
| | LED-TC-WIC-240 | 20' | Black | |
| | LED-TC-WIC-240-WT | 20' | White | |
|  | LED-TC-P-2 | 2' | Black | Lead Wire Alternative lengths for plug-in power supplies. |
| | LED-TC-P-2-WT | 2' | White | |
| | LED-TC-P-12 | 12' | Black | |
| | LED-TC-P-12-WT | 12' | White | |
|  | LED-TC-EXT-144 | 12' | Black | Extension Cable Extends distance between a hard wired power supply or a wiring box to a tape section. |
| | LED-TC-EXT-144-WT | 12' | White | |
|  | LED-TC-B-2 | L: 1½" W: ¾" H: ⅞" | Black | Low Voltage Wiring Box With Feed Neatly houses connections for up to two wires with 12" female feed. |
| | LED-TC-B-2-WT | | White | |
|  | LED-T-B | L: 1½" W: ¾" H: ⅞" | White | Low Voltage Wiring Box Neatly houses connections for up to two wires. |
|  | TB-S | L: 6¼" W: 1⅝" H: 1¼" | White | Wiring Box With Switch Use when spanning a large gap in a system layout without leaving exposed wiring. Optional switch included. |
| | Model | Dimension | Finish | Description |
|  | LED-TC-IC2 | 2" | Black | Joiner Cable Connects tape sections. |
| | LED-TC-IC2-WT | 2" | White | |
| | LED-TC-IC6 | 6" | Black | |
| | LED-TC-IC6-WT | 6" | White | |
| | LED-TC-IC12 | 12" | Black | |
| | LED-TC-IC12-WT | 12" | White | |
| | LED-TC-IC36 | 36" | Black | |
| | LED-TC-IC36-WT | 36" | White | |
| | LED-TC-IC72 | 72" | Black | |
| LED-TC-IC72-WT | 72" | White | | |
|  | LED-TC-MM | | Black | Connector. Male to male connector (pack of 50). Change directionality of tape runs and reuse cut ends of tape. |
| | Model | | Finish | Description |
|  | LED-TC-Y | | Black | 3-Way "Y" Connector Connects tape sections. |
| | LED-TC-Y-WT | | White | |
|  | LED-TC-X | | Black | 4-Way "X" Connector Connects tape sections. |
| | LED-TC-X-WT | | White | |
|  | LED-TC-L | | Black | "L" Connector Connects tape sections. |
| | LED-TC-L-WT | | White | |
|  | LED-TC-EC | | Black | End Cap 1 cut and 1 male end cap. |
| | LED-TC-EC-WT | | White | |
|  | T24-OD-SW60 | 5 ft | Black | DMX Joiner Cable - Satellite Connect between CTR-WDMX-24VDC Master to Satellite |
| | T24-OD-SW120 | 10 ft | | |
|  | T24-OD-MW60 | 5 ft | Black | DMX Joiner Cable - Universe Connect between DMX Universe to CTR-WDMX-24VDC |
| | T24-OD-MW120 | 10 ft | | |

INVISILED® PRO

Trimless Recessed Slim Channel

WAC

InvisILED Pro+ tape



- Installs within 5/8" drywall depth
- Linear channel can be field cut
- Accommodates either one or two runs of InvisILED Pro tape
- Includes a frosted acrylic diffuser

8FT LINEAR CHANNEL LED-T-RCH4-WT

Includes: 1 frosted diffuser
8 perforated metal sheets



POWER FEED LED-T-RBOX4-WT

The end cap may be placed on either side.
Hanger bars may be installed on any side of the wiring box.

- Includes:** 1 wiring box
2 hanger bars
2 end caps
2 channel connectors
1 counter sink drill bit
1 drill bit
2 power to tape connectors

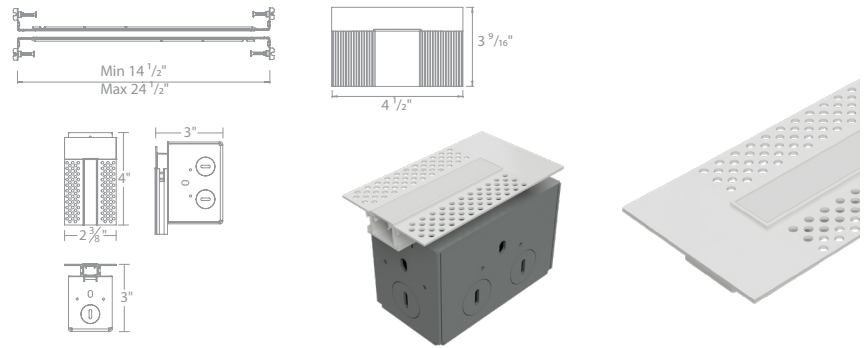

Trimmed Recessed Slim Channel

InvisILED Pro+ tape



- Installs within 5/8" drywall depth
- Linear channel can be field cut
- Accommodates either one or two runs of InvisILED Pro tape
- Includes a frosted acrylic diffuser

8FT LINEAR CHANNEL LED-T-RCH5-BK LED-T-RCH5-WT LED-T-RCH5-AL

Includes: 1 frosted diffuser
8 perforated metal sheets

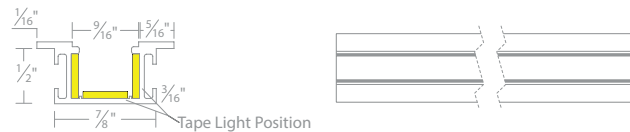

POWER FEED LED-T-RBOX5-BK LED-T-RBOX5-WT LED-T-RBOX5-AL

The end cap may be placed on either side.
Hanger bars may be installed on any side of the wiring box.

- Includes:** 1 wiring box
2 hanger bars
2 end caps
2 channel connectors
1 counter sink drill bit
1 drill bit
2 power to tape connectors

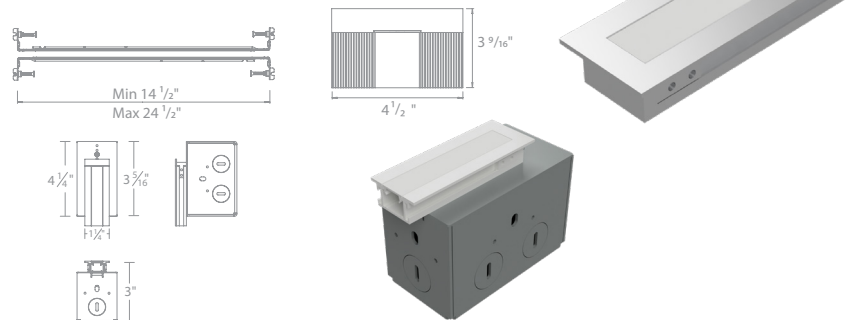

wacighting.com

Phone (800) 526.2588

Fax (800) 526.2585

Headquarters, East Manufacturing Facility

44 Harbor Park Drive

Port Washington, NY 11050

South East Manufacturing Facility

1600 Distribution Ct

Lithia Springs, GA 30122

Central Manufacturing Facility

1700 South J Elmer Freeway, Ste 100

Cedar Hill, TX 75104

West Manufacturing Facility

1750 S Archibald Ave

Ontario, CA 91761

INVISILED® PRO

Symmetrical Recessed Channel

WAC

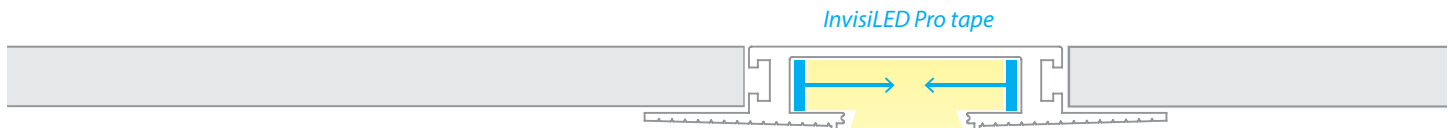

- Installs within 5/8" drywall depth
- Linear channel can be field cut
- Accommodates either one or two runs of InvisILED Pro tape
- Includes a translucent white acrylic diffuser
- Dense foam insert to be removed in installation after spackling

8FT LINEAR CHANNEL LED-T-RCH1-WT

Includes: 1 diffuser
8 perforated metal sheets

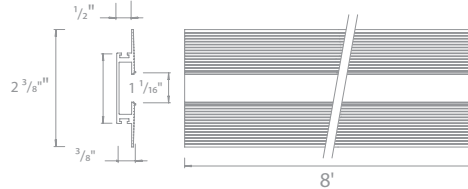

POWER FEED LED-T-RBOX1-WT

The end cap may be placed on either side.
Hanger bars may be installed on any side of the wiring box.

- Includes: 1 wiring box
2 hanger bars
4 five-pin InvisILED® adapters
2 end caps
1 diffuser
2 channel connectors
1 counter sink drill bit
1 drill bit
1 installation tool

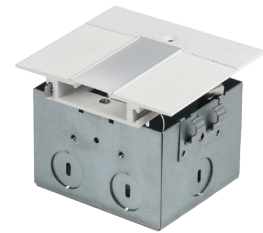
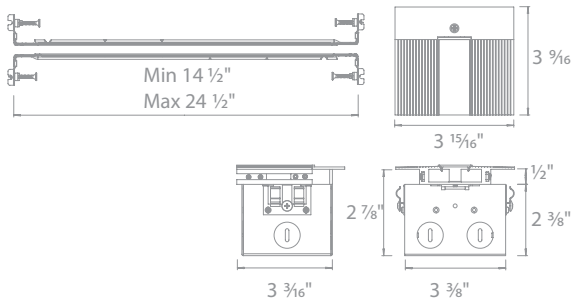

LATERAL CORNER LED-T-CTC1-WT

- Includes: 1 diffuser
2 channel connectors
2 perforated metal sheets

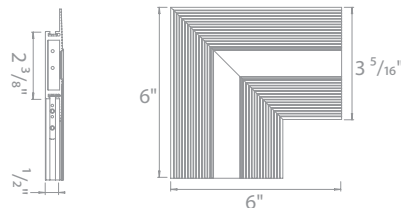

PERPENDICULAR CORNER LED-T-WTC1-WT

Transitions between walls or wall to ceiling

- Includes: 1 diffuser
2 channel connectors
2 perforated metal sheets

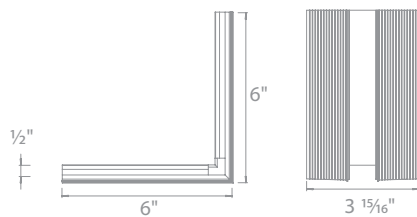

OUTSIDE CORNER LED-T-WTW1-WT

Transitions around columns, bump outs, or soffits

- Includes: 1 diffuser
2 channel connectors
2 perforated metal sheets

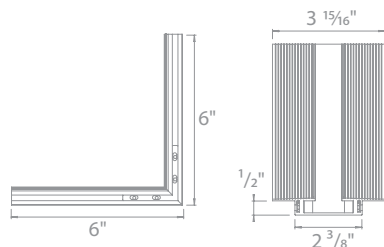

| | | | | |
|---|---|--|--|---|
| <p>wacighting.com Phone (800) 526.2588 Fax (800) 526.2585</p> | <p>Headquarters, East Manufacturing Facility 44 Harbor Park Drive Port Washington, NY 11050</p> | <p>South East Manufacturing Facility 1600 Distribution Ct Lithia Springs, GA 30122</p> | <p>Central Manufacturing Facility 1700 South J Elmer Freeway, Ste 100 Cedar Hill, TX 75104</p> | <p>West Manufacturing Facility 1750 S Archibald Ave Ontario, CA 91761</p> |
|---|---|--|--|---|

INVISILED® PRO

Asymmetrical Recessed Channel

WAC

- Installs within $\frac{5}{8}$ " drywall depth
- Linear channel can be field cut
- Accommodates one run of InvisILED Pro tape
- Dense foam insert to be removed in installation after spackling
- Recommended installation within 15 inches of surface to be illuminated



InvisILED Pro tape

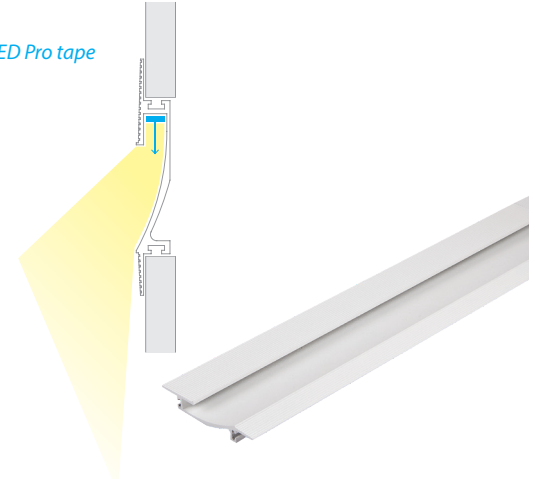

8FT LINEAR CHANNEL LED-T-RCH2-WT

Includes: 8 perforated metal sheets
2 channel connectors

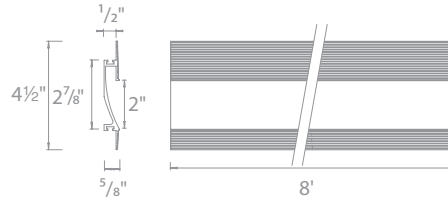

POWER FEED LED-T-RBOX2-WT

LED-T-RBOX2-WT

The end cap may be placed on either side. Hanger bars may be installed on any side of the wiring box.

Includes: 1 wiring box
2 hanger bars
2 five-pin InvisILED® adapters
2 end caps (left and right)
2 channel connectors
1 counter sink bit
1 drill bit

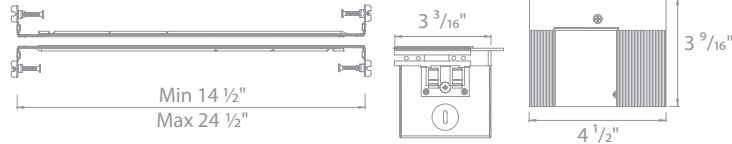

Indirect Recessed Slim Channel

- Linear channel can be field cut
- Dense foam insert to be removed in installation after spackling
- Allows option to use different color InvisILED Pro tape in one channel and switch them separately

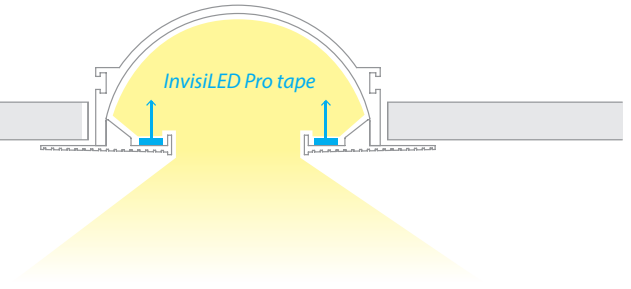
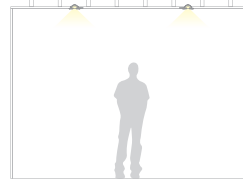

8FT LINEAR CHANNEL LED-T-RCH3-WT

Includes: 10 perforated metal sheets
2 channel connectors

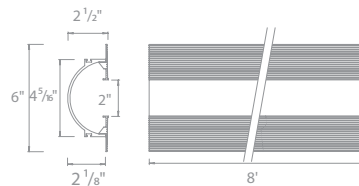

POWER FEED LED-T-RBOX3-WT

LED-T-RBOX3-WT

The end cap may be placed on either side.
Hanger bars may be installed on any side of the wiring box.

Includes: 1 wiring box
2 hanger bars
4 five-pin InvisILED® adapters
1 end cap
2 channel connectors
1 counter sink bit
1 drill bit

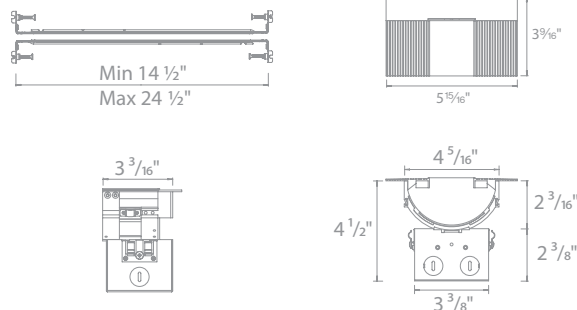

wacighting.com

Phone (800) 526.2588

Fax (800) 526.2585

Headquarters, East Manufacturing Facility

44 Harbor Park Drive

Port Washington, NY 11050

South East Manufacturing Facility

1600 Distribution Ct

Lithia Springs, GA 30122

Central Manufacturing Facility

1700 South J Elmer Freeway, Ste 100

Cedar Hill, TX 75104

West Manufacturing Facility

1750 S Archibald Ave

Ontario, CA 91761

INVISILED® PRO

Angled Recessed Channel

WAC

InvisILED Pro+ tape



- Recessed asymmetrical distribution provides a clean wash of illumination
- Linear channel can be field cut
- Accommodates one run of InvisILED Pro tape
- Includes a frosted acrylic diffuser

5FT LINEAR CHANNEL

LED-T-CH6-BK
LED-T-CH6-WT
LED-T-CH6-AL

ADDITIONAL END CAPS

LED-T-CH6-EC-BK
LED-T-CH6-EC-WT
LED-T-CH6-EC-AL

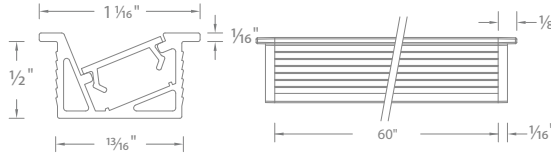

Includes: 1 frosted diffuser
2 end caps

Indoor Aluminum Channels

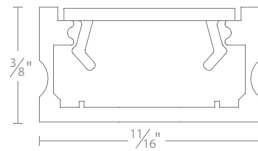

SHALLOW ALUMINUM CHANNEL

LED-T-CH5-BK
LED-T-CH5-WT
LED-T-CH5-AL

ADDITIONAL END CAPS

LED-T-CH5-EC-BK
LED-T-CH5-EC-WT
LED-T-CH5-EC-AL

Includes a diffuser, 2 end caps, and 5 screws.

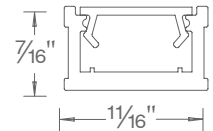

ALUMINUM CHANNEL ADDITIONAL END CAPS

LED-T-CH 5'
LED-T-CH-EC 2 pcs

Diffuses light from Gemini tape.
Includes a diffuser, 2 end caps, and 5 screws.

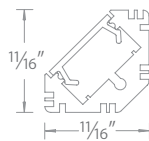

45° ANGLED ALUMINUM CHANNEL ADDITIONAL END CAPS

LED-T-CH2 5'
LED-T-CH2-EC 2 pcs

Includes a diffuser, 2 end caps, and 5 screws.

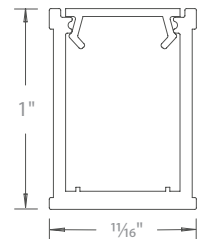

DEEP ALUMINUM CHANNEL ADDITIONAL END CAPS

LED-T-CH1 5'
LED-T-CH1-EC 2 pcs

Eliminates visible hot spots.
Includes a diffuser, 2 end caps, and 5 screws.

wacighting.com

Phone (800) 526.2588

Fax (800) 526.2585

Headquarters, East Manufacturing Facility

44 Harbor Park Drive

Port Washington, NY 11050

South East Manufacturing Facility

1600 Distribution Ct

Lithia Springs, GA 30122

Central Manufacturing Facility

1700 South J Elmer Freeway, Ste 100

Cedar Hill, TX 75104

West Manufacturing Facility

1750 S Archibald Ave

Ontario, CA 91761

INVISILED® PRO

Indoor Mounting Accessories

WAC



ALUMINUM RETROFIT CHANNEL LED-T-RC 3 feet

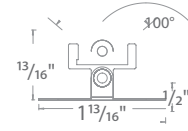

ADJUSTABLE CHANNEL CLIP LED-T-CL2-PT

Includes 2 pieces, 4 screws. Used to mount Aluminum Channel. Adjust 50° from center either way.



FIXED ANGLE CHANNEL CLIP LED-T-CL3-PT



Clip LED-T-CL **Curve Clip** LED-T-CL1

For surfaces that are difficult to adhere. Includes: 10 pcs plastic clips and 10 pcs screws. Compatible with InvisiLED Lite+, Pro+ and Pro2+ only.

Clips to hold indoor InvisiLED tapes sections. Includes: 10 pcs plastic clips and 10 pcs screws. Compatible with InvisiLED Lite+, Pro+ and Pro2+ only

Optical Channels and Lens Accessories

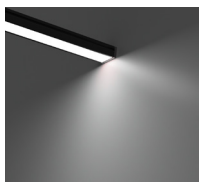

FROSTED DIFFUSER LED-T-CH5-COV-FR 5'
LED-T-CH8-COV-FR 8'

Standard diffuser included with channel.

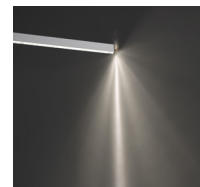

SPOT OPTIC DEEP CHANNEL LED-T-CH3-SP 5'
ADDITIONAL END CAPS LED-T-CH1-EC 2 pcs

Eliminates visible hot spots. Includes a diffuser, 2 end caps, and 5 screws.

Spot 9° Beam Angle



SEMI-CLEAR DIFFUSER LED-T-CH5-COV-SF 5'
LED-T-CH8-COV-SF 8'

Optional diffuser available, order separately.

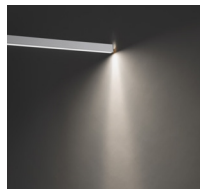

FLOOD OPTIC DEEP CHANNEL LED-T-CH3-FL 5'
ADDITIONAL END CAPS LED-T-CH1-EC 2 pcs

Eliminates visible hot spots. Includes a diffuser, 2 end caps, and 5 screws.

Flood 54° Beam Angle



BLACK DIFFUSER LED-T-CH5-COV-BK 5'
LED-T-CH8-COV-BK 8'

Optional diffuser available, order separately.

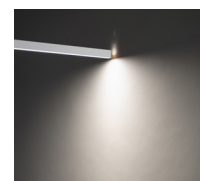

WIDE FLOOD OPTIC DEEP CHANNEL LED-T-CH3-WF 5'
ADDITIONAL END CAPS LED-T-CH1-EC 2 pcs

Eliminates visible hot spots. Includes a diffuser, 2 end caps, and 5 screws.

Wide Flood 84° Beam Angle

wacighting.com
Phone (800) 526.2588
Fax (800) 526.2585

Headquarters, East Manufacturing Facility
44 Harbor Park Drive
Port Washington, NY 11050

South East Manufacturing Facility
1600 Distribution Ct
Lithia Springs, GA 30122

Central Manufacturing Facility
1700 South J Elmer Freeway, Ste 100
Cedar Hill, TX 75104

West Manufacturing Facility
1750 S Archibald Ave
Ontario, CA 91761