

The TruAudio outdoor enclosure is your ultimate shield, built to conquer the harshest environments while keeping your equipment safe and sound. With built-in fan and a pre-installed bracket perfectly designed for the TruAudio T100 amplifier and VSSL A.1x, this rugged, weatherproof enclosure offers unparalleled protection. When running cable into the house isn't an option, this enclosure becomes your go-to solution for seamless outdoor audio experiences.

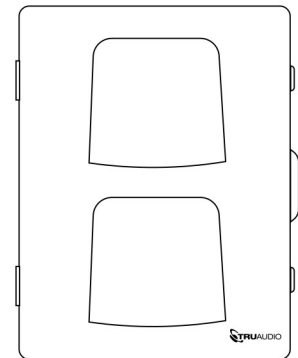

## INSTALLATION

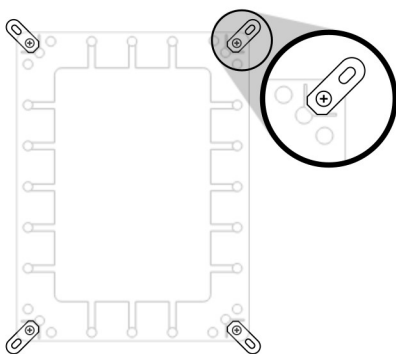

1. Install the four wall-mount brackets to the backside of the outdoor enclosure using the included screws.

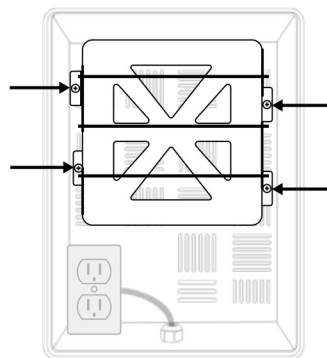

2. Remove the T100/A.1x bracket by removing the 4 screws that are securing the bracket to the enclosure plate.

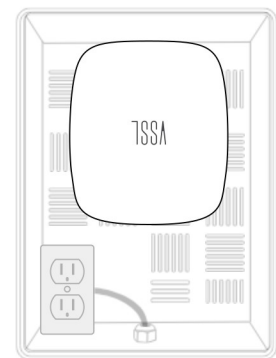

3. Secure the VSSL A.1x to the enclosure plate using the included velcro.

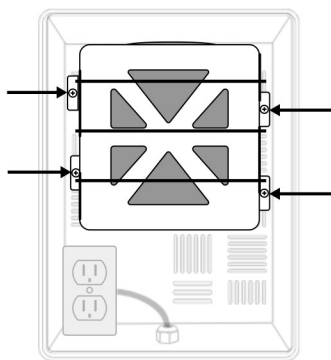

4. Install the T100/A.1x bracket using the 4 screws that were removed in step 2.

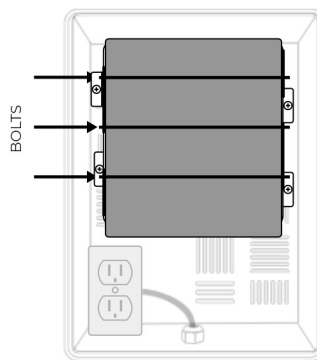

5. Loosen the horizontal bolts until they move up and down freely and insert the T100. Secure the T100 to the enclosure plate using the included velcro. Tighten the bolts to securely fasten the T100 in place.

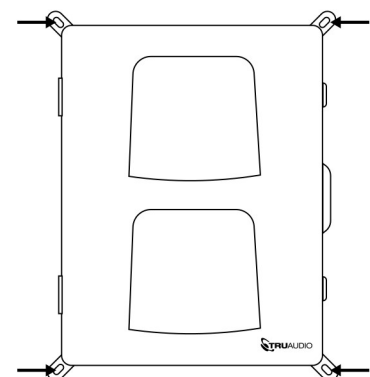

6. Use the included screws and anchors to mount the outdoor enclosure to any surface.

