

## S95F 55/65/77/83" Dimensions

	S95F 55"	S95F 65"	S95F 77"	S95F 83"
SET(With stand) (W * H * D)	1224.6 * 771.4 * 267.9	1443.5 * 894.4 * 267.9	1716.6 * 1048.1 * 286.4	1844.2 * 1123.4 * 303.7
SET(With stand & With OC) (W * H * D)	1224.6 * 771.4 * 290.7	1443.5 * 894.4 * 290.7	1716.6 * 1048.1 * 309.5	1844.2 * 1123.4 * 332.8
SET(Without stand) (W * H2(H1) * D1(D2))	1224.6 * 706.3(700.8) * 10.98(12.38)	1443.5 * 829.4(823.9) * 10.98(12.28)	1716.6 * 984.1(978.6) * 11.18(12.48)	1844.2 * 1056.8(1051.3) * 12.6
* Front Opening Area (A * B * C)	1221.6 * 692.3 * 1404.1	1440.5 * 813.9 * 1654.5	1713.6 * 968.5 * 1968.4	1841.2 * 1048.3 * 2118.7
Wall Mount (a * b)	400 * 300	400 * 300	400 * 400	400 * 400
Packing Out (W * H * D)	1432 * 818 * 165	1625 * 935 * 170	1893 * 1153 * 185	2055.0 * 1219.0 * 191.0
Net Weight (With stand) Kg	23.9	29.0	40.0	51.9
Net Weight (Without stand) Kg	13.8	18.9	28.2	38.6
Gross Weight (Packing) Kg	33.1	39.8	54.0	68.1

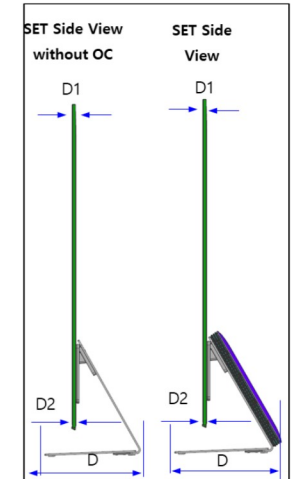

\* D1 : Official Depth (W/O LOGO)  
\* D2 : Including LOGO

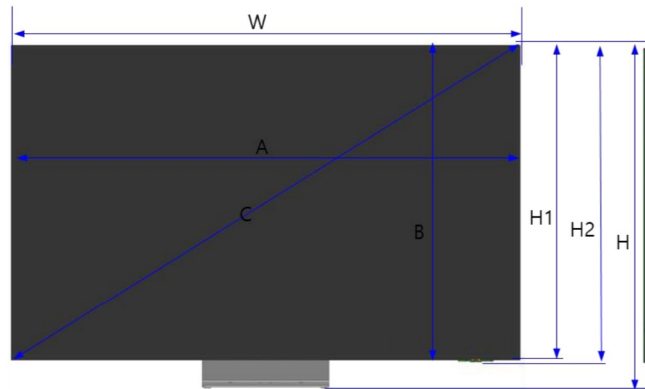

SET Front View

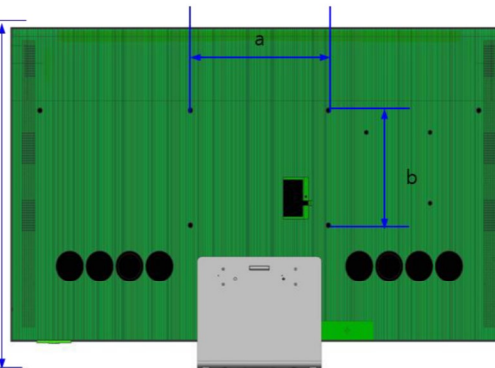

SET Rear View without OC

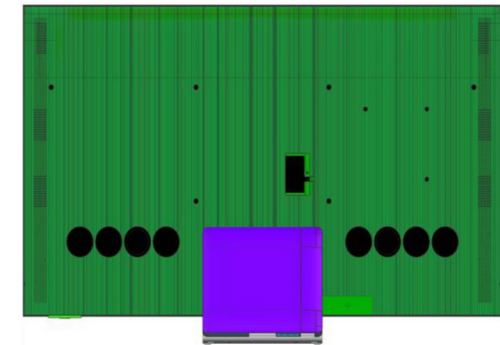

SET Rear View with OC

*SAMSUNG IS NOT RESPONSIBLE FOR INACCURACIES. FOR CRITICAL INSTALLATIONS, IT IS STRONGLY RECOMMENDED TO CONFIRM ALL MEASURES BY USING AN ACTUAL SAMPLE MODEL INTENDED FOR A SPECIFIC INSTALLATION.*

*\*Dimensions in millimeters (+ / - 0.1 mm)*

## S95F Cover and Rear-View Dimensions

		S95F			
		55"	65"	77"	83"
VESA WALL MOUNT(AXB)		400 X 300	400 X 300	400 X 400	400 X 400
C		412.3	521.8	658.3	722.1
D		160.7	217.3	317.4	219.9
E		240.1	306.7	261.2	431.4
Screw Depth		5-6	5-6	5-6	5-6
SLIM WALL MOUNT	H	160.7	217.3	317.4	219.9
	I	85.1	85.2	109.6	107.5
WALL MOUNT OC	J	-	274.8	424.9	497.6
	K	-	185.0	185.0	185.0
	L	-	226.6	281.9	296.9
	M	-	185.0	185.0	185.0

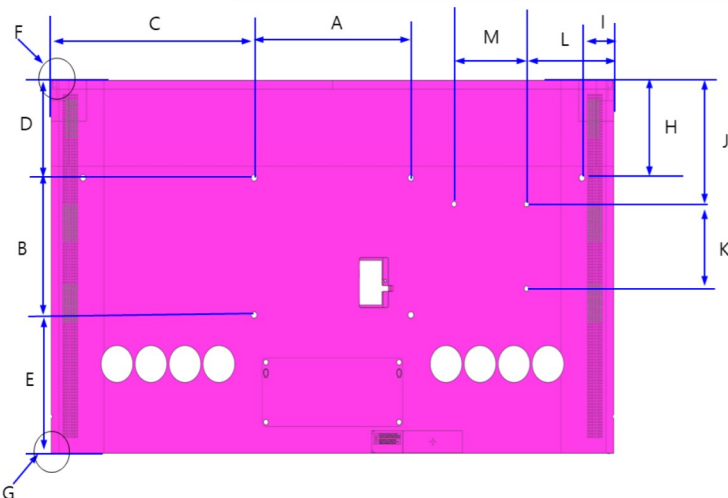

Detail "F"

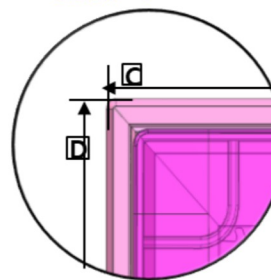

Detail "G"

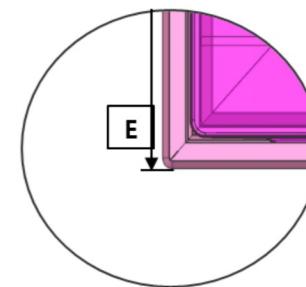

※ C,D  
1) SET's Outermost spec (Chassis-Front & C/Rear)

SAMSUNG IS NOT RESPONSIBLE FOR INACCURACIES. FOR CRITICAL INSTALLATIONS, IT IS STRONGLY RECOMMENDED TO CONFIRM ALL MEASURES BY USING AN ACTUAL SAMPLE MODEL INTENDED FOR A SPECIFIC INSTALLATION.

*\*Dimensions in millimeters (+ / - 0.1 mm)*

## S95F 55" Cover and Rear-View Dimensions

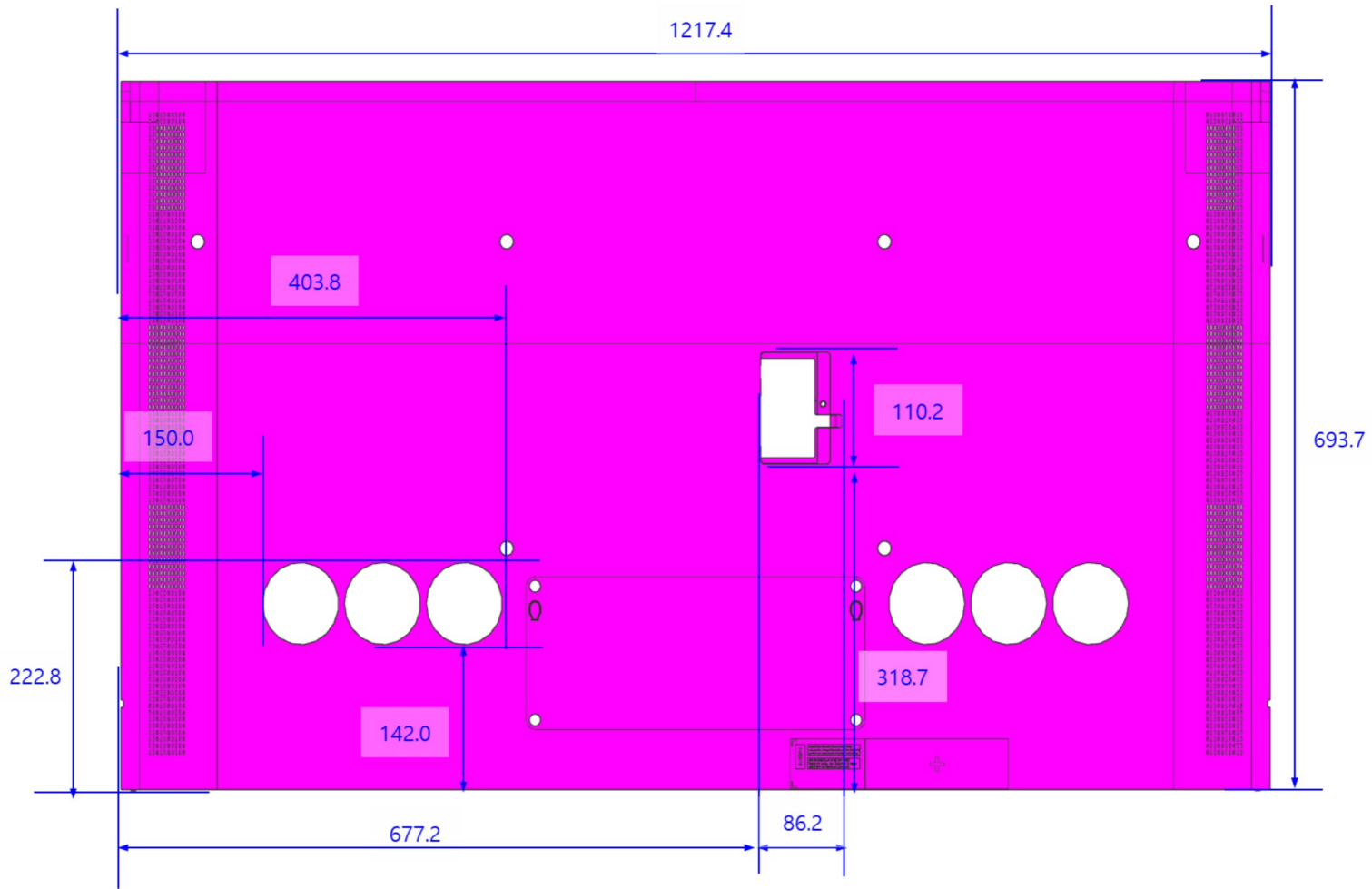

*SAMSUNG IS NOT RESPONSIBLE FOR INACCURACIES. FOR CRITICAL INSTALLATIONS, IT IS STRONGLY RECOMMENDED TO CONFIRM ALL MEASURES BY USING AN ACTUAL SAMPLE MODEL INTENDED FOR A SPECIFIC INSTALLATION.*

*\*Dimensions in millimeters (+ / - 0.1 mm)*

## S95F 65" Cover and Rear-View Dimensions

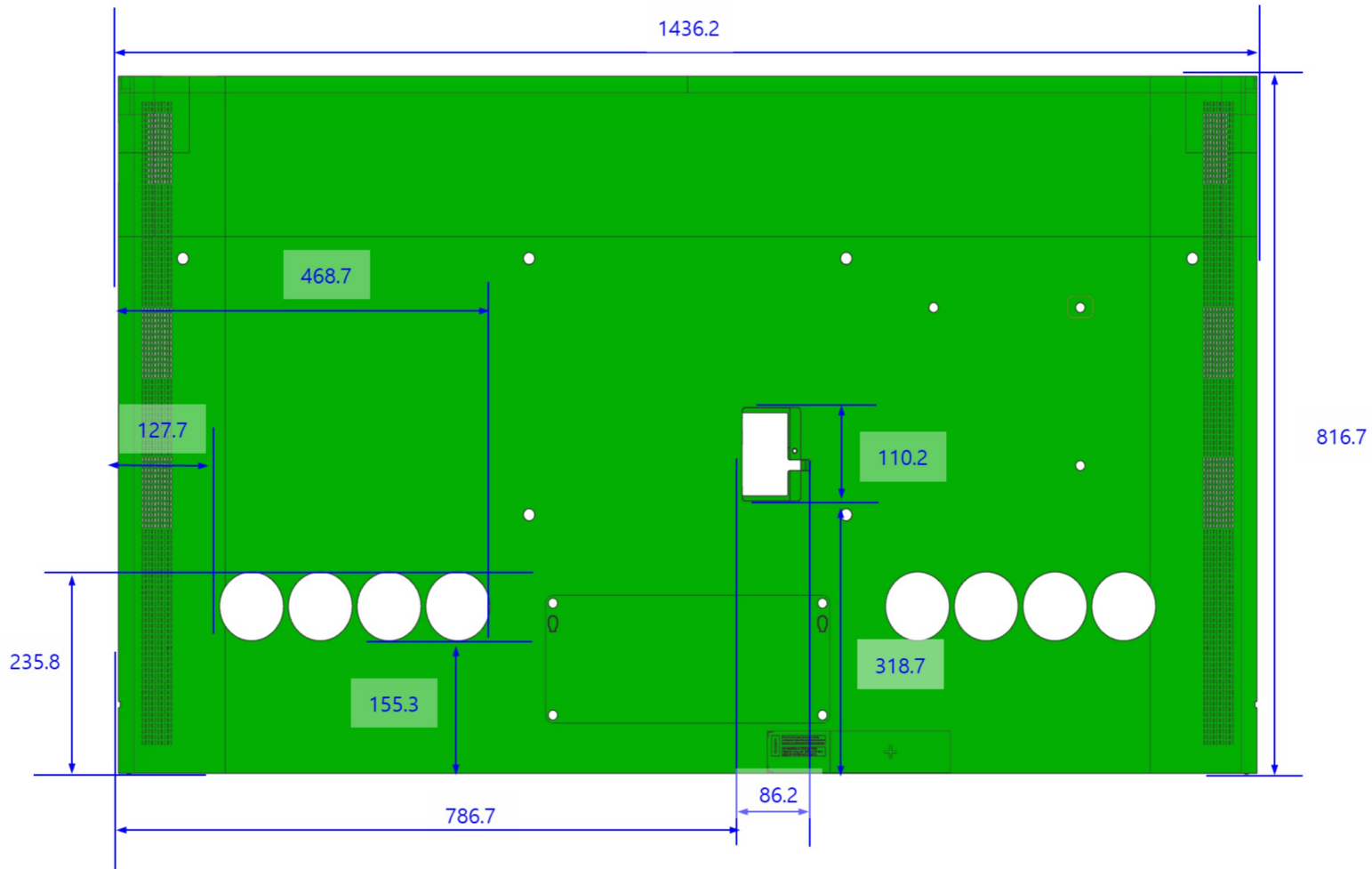

*SAMSUNG IS NOT RESPONSIBLE FOR INACCURACIES. FOR CRITICAL INSTALLATIONS, IT IS STRONGLY RECOMMENDED TO CONFIRM ALL MEASURES BY USING AN ACTUAL SAMPLE MODEL INTENDED FOR A SPECIFIC INSTALLATION.*

# S95F

*\*Dimensions in millimeters (+ / - 0.1 mm)*

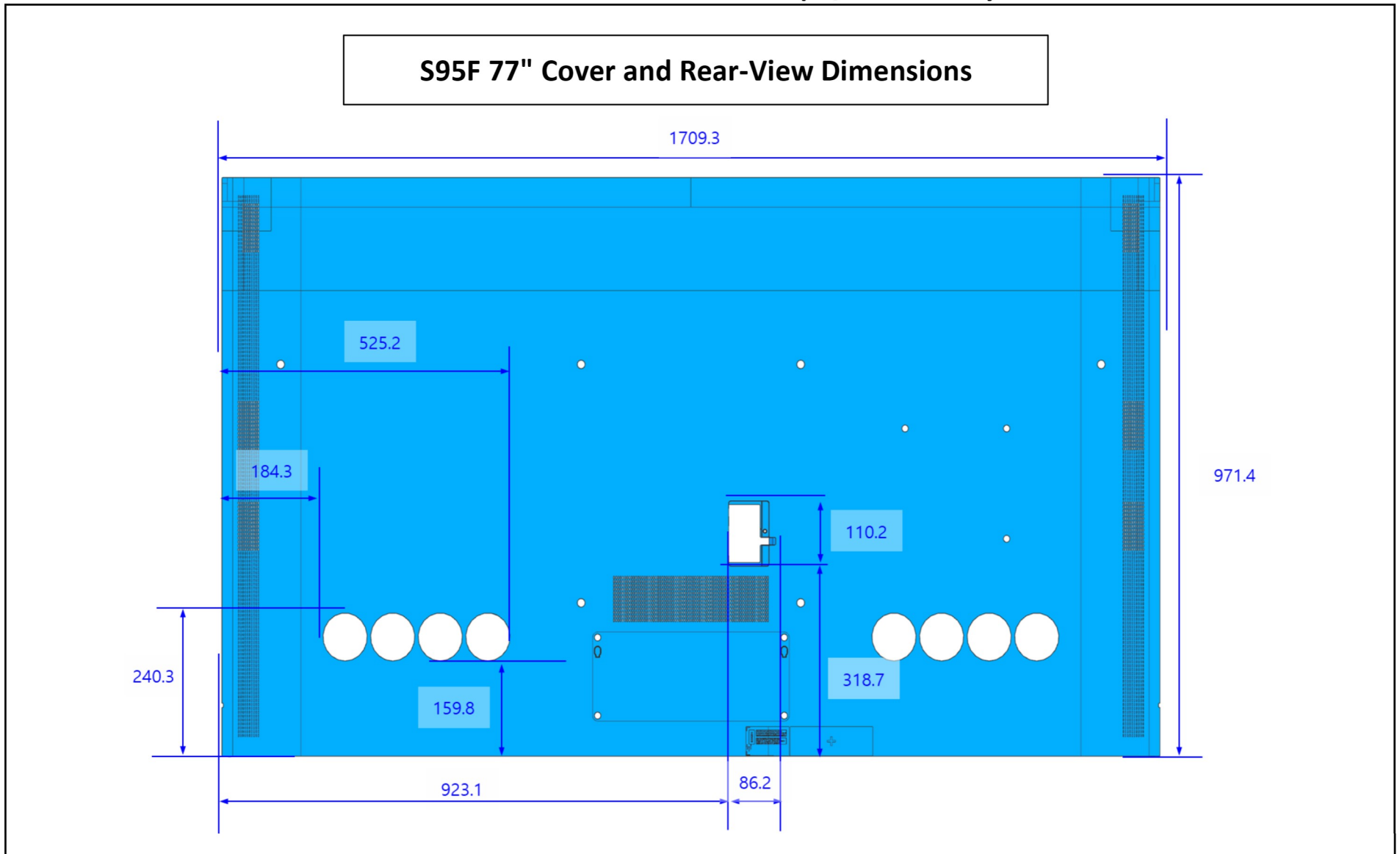

*SAMSUNG IS NOT RESPONSIBLE FOR INACCURACIES. FOR CRITICAL INSTALLATIONS, IT IS STRONGLY RECOMMENDED TO CONFIRM ALL MEASURES BY USING AN ACTUAL SAMPLE MODEL INTENDED FOR A SPECIFIC INSTALLATION.*

*\*Dimensions in millimeters (+ / - 0.1 mm)*

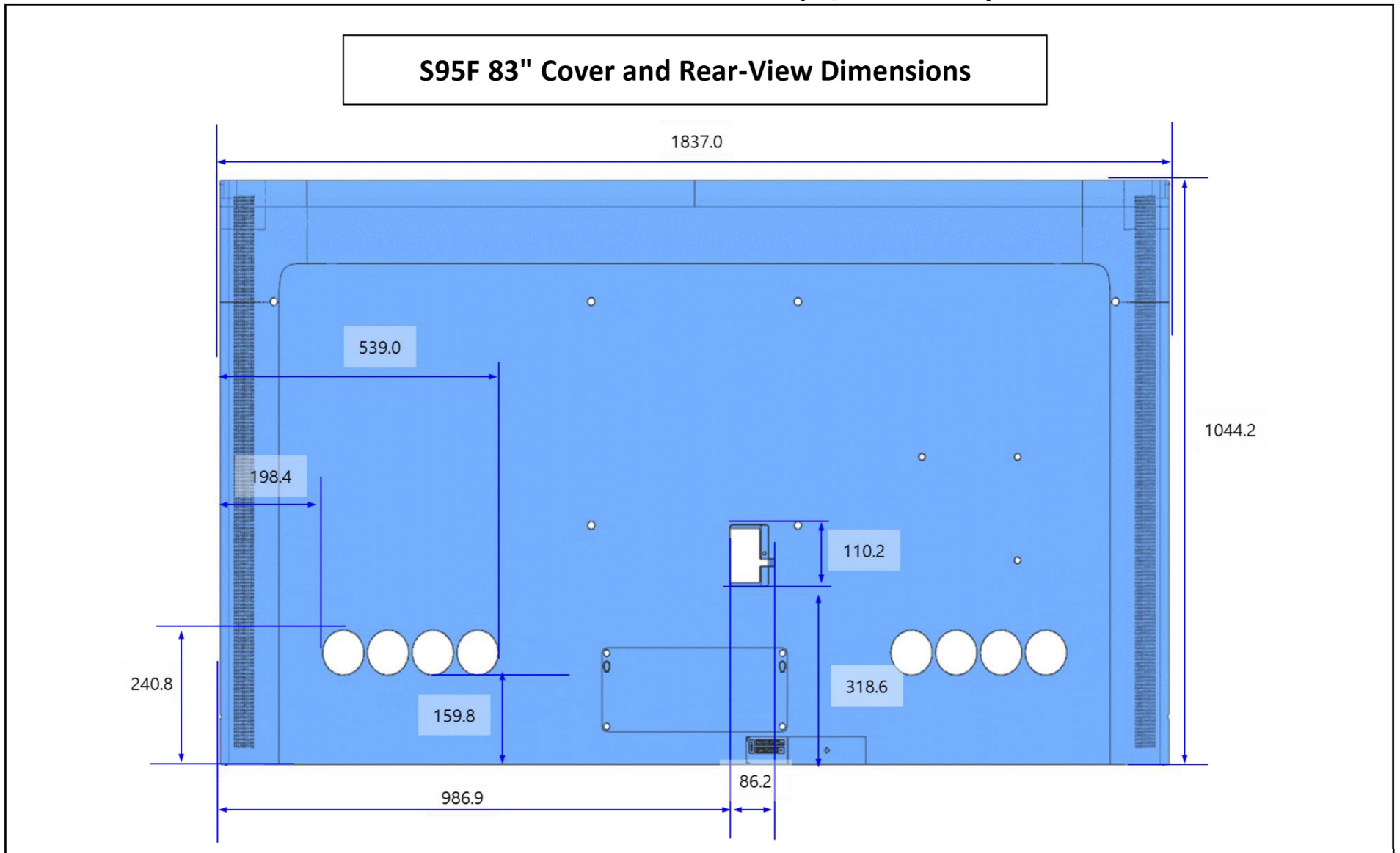

*SAMSUNG IS NOT RESPONSIBLE FOR INACCURACIES. FOR CRITICAL INSTALLATIONS, IT IS STRONGLY RECOMMENDED TO CONFIRM ALL MEASURES BY USING AN ACTUAL SAMPLE MODEL INTENDED FOR A SPECIFIC INSTALLATION.*

# S95F

*\*Dimensions in millimeters (+ / - 0.1 mm)*

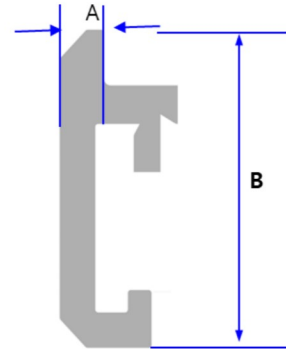
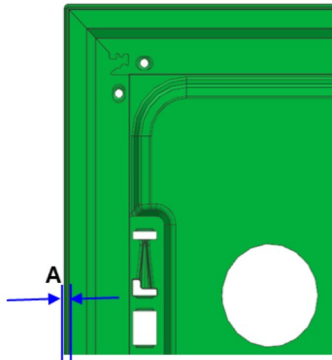

Top/Left/Right

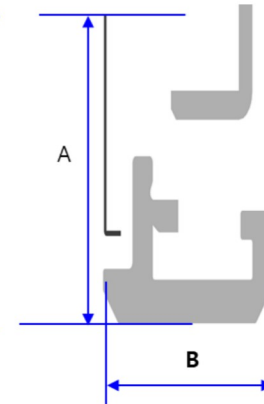

Bottom

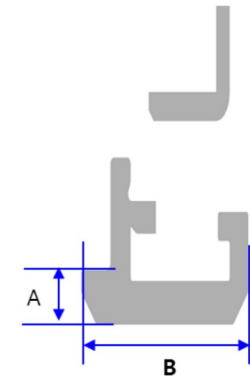

Bottom

## S95F Bezel Dimensions

	S95F							
	55"		65"		77"		83"	
	T/L/R	Bottom	T/L/R	Bottom	T/L/R	Bottom	T/L/R	Bottom
<b>A</b>	1.5	8.5	1.5	8.5	1.5	8.6	1.5	1.5
<b>B</b>	9.9		9.9		9.9		9.9	

*SAMSUNG IS NOT RESPONSIBLE FOR INACCURACIES. FOR CRITICAL INSTALLATIONS, IT IS STRONGLY RECOMMENDED TO CONFIRM ALL MEASURES BY USING AN ACTUAL SAMPLE MODEL INTENDED FOR A SPECIFIC INSTALLATION.*

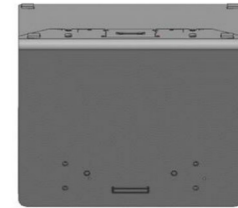
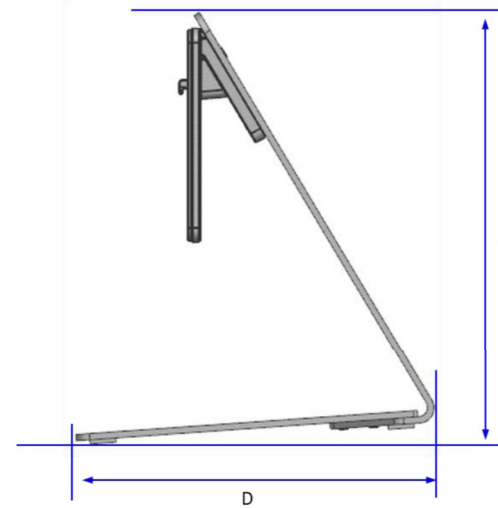
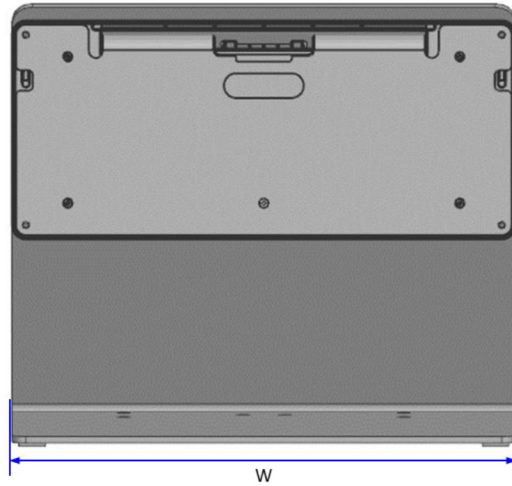

## S95F Stand Dimensions

	S95F		
	55/65"	77"	83"
<b>CENTER STAND (W*H*D)</b>	360.0*296.6*267.9	360.0*296.4*286.4	360.0*296.9*303.7

*SAMSUNG IS NOT RESPONSIBLE FOR INACCURACIES. FOR CRITICAL INSTALLATIONS,  
IT IS STRONGLY RECOMMENDED TO CONFIRM ALL MEASUREMENTS USING THE SPECIFIC TV TO BE INSTALLED.*

# S95F

*\*Dimensions in millimeters (+ / - 0.1 mm)*

## S95F One Connect Box and Cable

	S95F	(83") S95F
OC BOX (with COVER) (W*H*D)	360.0 * 32.9 * 330.0	360.0 * 39.7 * 330.0
OC BOX (without COVER) (W*H*D)	295.0 * 32.9 * 330.0	295.1 * 39.7 * 330.0

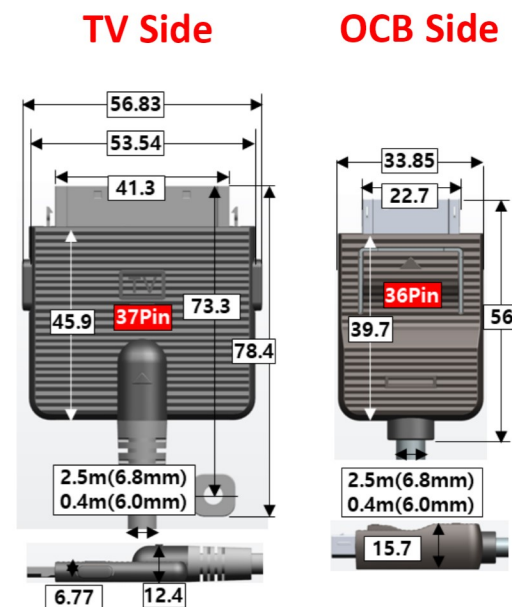
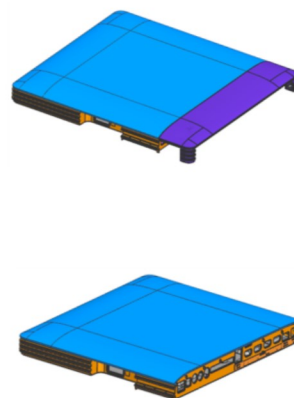
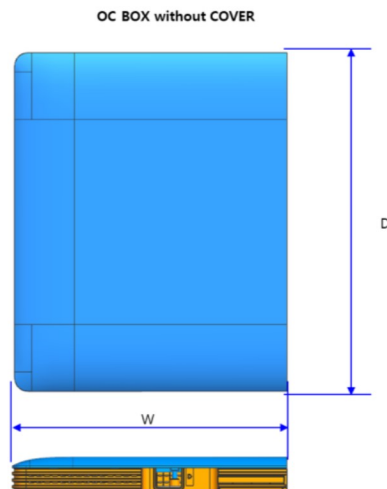
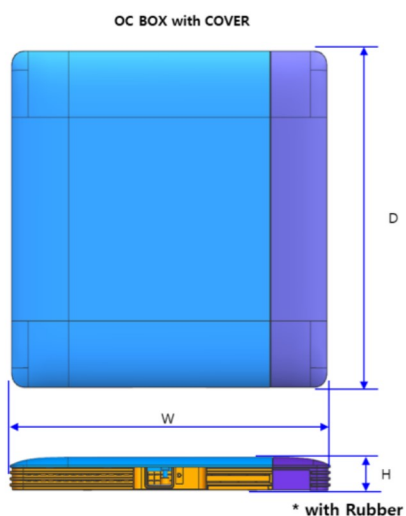

**Included One Connect Cables:**

Short: .4M

Long: 2.5M

*SAMSUNG IS NOT RESPONSIBLE FOR INACCURACIES. FOR CRITICAL INSTALLATIONS, IT IS STRONGLY RECOMMENDED TO CONFIRM ALL MEASURES BY USING AN ACTUAL SAMPLE MODEL INTENDED FOR A SPECIFIC INSTALLATION.*

**2025 IR Sensor Location**

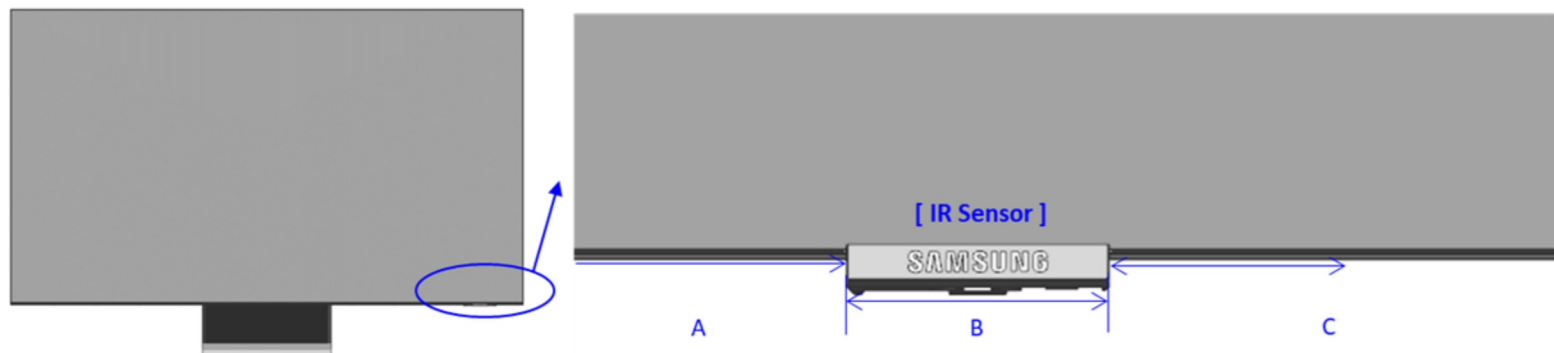

Product	Series	Inch	Item	Sensor Position	DIMENSION		
					A	B	C
OLED	S95F	83	QN83S95FAEXZA	Right	1709.2	24.7	110.3
		77	QN77S95FAFXZA	Right	1590.4	24.7	101.4
		65	QN65S95FAFXZA	Right	1304.9	24.7	114
		55	QN55S95FAFXZA	Right	1104.2	24.7	95.7

*SAMSUNG IS NOT RESPONSIBLE FOR INACCURACIES. FOR CRITICAL INSTALLATIONS, IT IS STRONGLY RECOMMENDED TO CONFIRM ALL MEASUREMENTS USING THE SPECIFIC TV TO BE INSTALLED.*