

The remote volume section on the rear panel of the RM424 allows the installer to place remote volume controls in any or all of the zones connected to the RM424. Wiring information is silk screened above each remote volume connector.

Q: Does the remote volume wire carry audio signal?

A: No, the remote volume wire only carries a DC control voltage that varies according to the position of the remote volume pot (10-100K Ohm linear potentiometer recommended). Use of the remote volume feature will not introduce any noise or cause any signal loss.

Q: What is the maximum length that I can run a remote volume wire?

A: Wire size can affect the maximum length. You can run up to 200 feet reliably, and with high quality wire up to 1000 feet.

Below is a diagram of how to connect the pots to the remote volume Phoenix connectors.

REMOTE PAD: 5 pin Phoenix connector for connection to a remote potentiometer for remote volume control. A 100K Ohm audio taper potentiometer is recommended (others will work).

+15: Connection to potentiometer.

WIPER: Connection to potentiometers wiper (middle pin).

COMM: Common Ground for connection to pots.

As a note: If the potentiometer pad is working opposite of what you intended just reverse the wires going to that potentiometer.

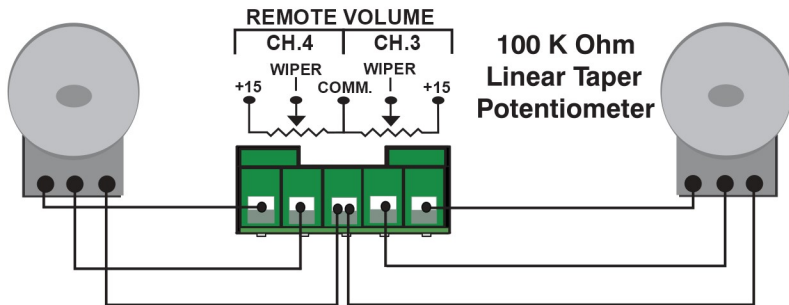

ROLLS

ROLLS CORPORATION
SALT LAKE CITY, UTAH
01/13

ROLLS

RM424
4 Zone Mixer

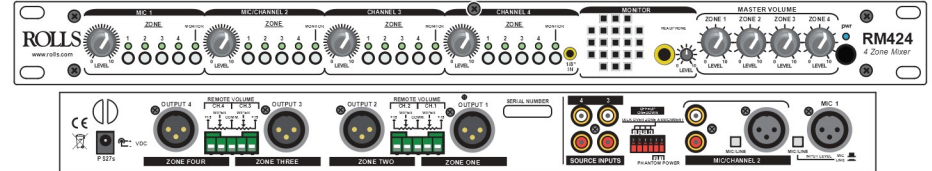

SPECIFICATIONS

Input Impedance:	10K Ohms balanced Line 600 Ohms balanced Mic 10K Ohms unbalanced RCA 50 Ohms balanced XLR
Output Impedance:	
Max Input Level:	Mic: -30 dB Source: +22 dB
Phantom Power:	+48 Volts DC
Input Connectors:	XLR and RCA
Outputs:	4 ea. XLR
Max Gain:	60 dB mic 30 dB line
S/N Ratio:	>75 dB
THD:	< .3%
IMD (SMPTE):	< .3%
CMRR:	60 dB
Frequency Response:	20Hz to 20kHz +/- 0 dB
Power Adapter:	15VDC
Weight:	7 lbs (3KG)
Size:	19" x 1.75" x 6.5" (48cm x 4.5cm x 17cm)

NOTE: THIS MANUAL ASSUMES THE USER HAS A WORKING KNOWLEDGE OF AUDIO ELECTRONICS, BALANCED AND UNBALANCED CONNECTIONS, AND PROPER SIGNAL LEVEL SETTINGS. FOR PROPER SETUP AND USE CONTACT YOUR DEALER.

ROLLS CORPORATION
5968 South 350 West
Salt Lake City, UT 84107
Phone (801) 263-9053
FAX (801) 263-9068
www.rolls.com

Quick Start Guide

INSPECTION

1. Unpack and inspect the RM424 box and package. If obvious physical damage is noticed, contact the carrier immediately to make a damage claim. We suggest saving the shipping carton and packing materials for safely transporting the unit in the future.
2. Please visit our web site at www.rolls.com and click on the Register Your Warranty Here button.

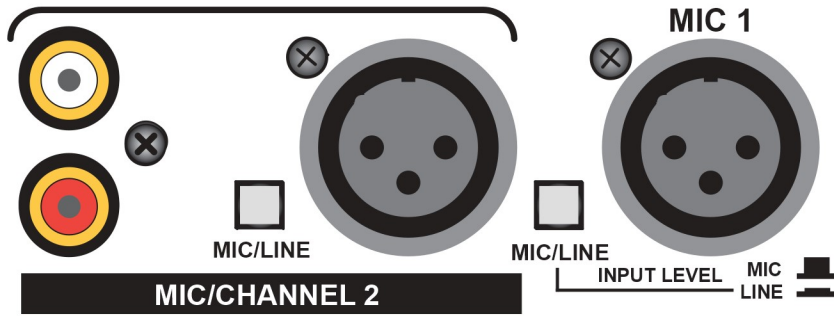

The XLR input for MIC 1 can be configured to be Microphone level or line level. Follow the silk screening of the unit for proper use of the mic/line switch.

MIC/CHANNEL 2 is a single input channel that can be XLR input (mic or line as described above) or an RCA input. The RCA input is always line level, the MIC/LINE switch does not effect the RCA input.

- Q: When I plug a mic into the RM424 I can barely hear it?
 A: The MIC/LINE switch is set to LINE level and you are using a MIC, set the switch to MIC. Make sure other volumes of the unit are set properly.
- Q: Can I use the XLR and RCA input of CH 2 at the same time?
 A: Yes, but you will have no way of attenuating the volume of each source separately.

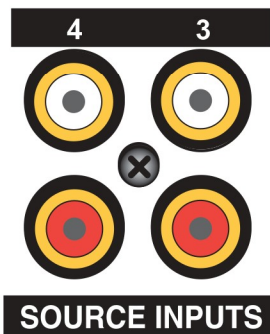

- Channel 3 and 4 inputs are line level RCA's.
- Q: I only have a single mono RCA to connect to the source inputs do I need to get a "Y" type adapter?
 A: No, the RM424 will accept a mono or stereo signal into the RCA inputs, and will convert all signals to mono. No "Y" adapter is needed.

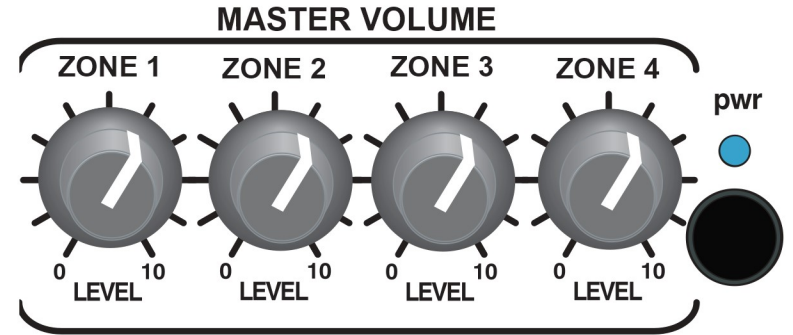

The MASTER VOLUME controls on the front of the RM424 function just as the name implies. NOTE: with channel volumes, master volumes and possibly remote volumes there are plenty of opportunities to get distortion on the outputs. It is best to set all volumes at half (white pointer facing up). Then make adjustments from there as needed.

- Q: When using a remote volume does the MASTER VOLUME control still work?
 A: Yes, when using a remote volume both the remote volume and master volumes are active. We suggest if you are using a remote volume to set the master volume to 10 (all the way up) to give the remote volume access to the full volume potential of the RM424.

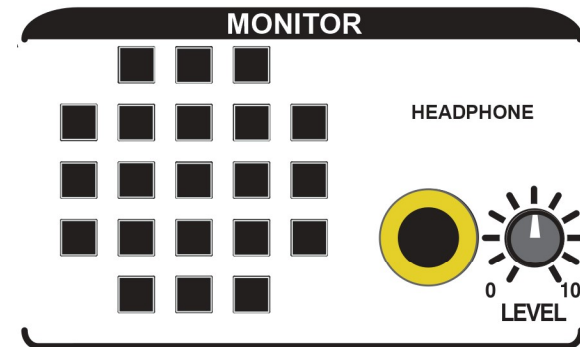

- The MONITOR section of the RM424 is designed to be able to monitor a signal before it is sent to a zone.
- EX: If you are going to send audio from a music player connected to input 3 to zone 4 output, but you want to be sure the sound is correct you can preview (monitor) it before sending it to zone 4 output. By selecting MONITOR on the input 3 section of the front panel, you can either listen to the signal from the speaker on the front panel or plug in headphones to MONITOR the signal before you select input 3 to be sent out to zone 4 output. This can be done in any combination of channels etc. The Volume level for the monitor is for either the headphones or the speaker. When headphones are plugged in to the headphone monitor jack the speaker is disabled allowing you to monitor quietly.
- Q: The monitor works with source signals but seems to be low with mic's?
 A: The unit is working fine, the problem is that the small speaker on the front of the RM424 is sending out a signal to monitor the mic, but the mic is lower in volume than the line level signals. We recommend using the headphone output to monitor sensitive information.

OPERATION AND SET UP

DIP SWITCH SETTINGS

- PHANTOM POWER: This applies 48 volts phantom power to the indicated microphone.
- Talk Over Zone Assignment 1: When in the ON position, all program material on **ZONE 1** will be “ducked” or muted when signal is present on MICROPHONE 1 or MICROPHONE 2. This function is used for paging.
- Talk Over Zone Assignment 2,3 and 4 are the same as above.

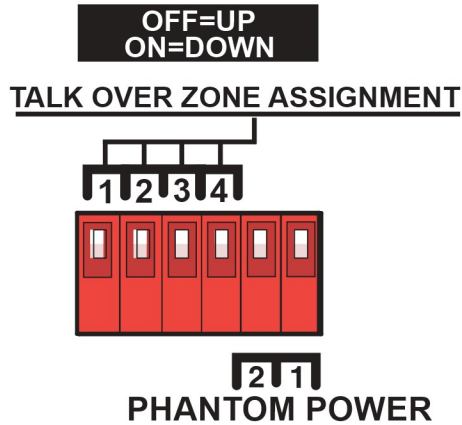

TALK OVER:

The talk over is designed to allow both mic 1 or mic/line 2 inputs to talk over the other inputs (3 and 4).

EX: If the talk over assignment is engaged for CH.1 output then when ever signal is present on either mic 1 input or mic/line CH 2 inputs those signals will talk over channel 3 or 4 inputs. Keep in mind that these channels need to be selected to the same output section from the front panel for this to function properly.

The designation on the rear of the RM424 is for engaging/selecting the talkover for one of the four output channels. You can have the RM424 talk over function only on the output channels you select from the rear of the unit, as pictured above.

Q: Will mic 1 talk over mic 2?

A: No, both mic 1 and mic 2 will talk over inputs 3 and 4, but not each other.

Q: I can not get the TALK OVER to function?

A: In addition to having everything selected properly make sure you have enough signal present on the Mic inputs to activate the Talk Over circuit. If the signal to those channels is to low it will not activate the circuit. To try and remedy this turn the level of the mics/inputs up.

Q: Channel 2 has a Mic and an RCA input will both of these inputs talk over?

A: Yes, both the XLR and RCA inputs on CH 2 are connected to the talk over circuit, and will talk over CH 3 and 4.

PHANTOM POWER:

The RM424 provides 48 volts of phantom power to the selected channel (Mic 1 or Mic 2). These are selected independently of each other from the rear panel of the unit, see above illustration.

Q: I cannot hear my mic it is not a phantom power (condenser) type mic. Does it matter that I have the phantom power turned on?

A: Yes, it does matter. If you are using a dynamic mic (one that does not require phantom power), you must have the phantom power turned off. When the phantom power is on it will not allow you to hear the mic. It also may damage the RM424, or your mic, to have the phantom power engaged when using a dynamic mic.

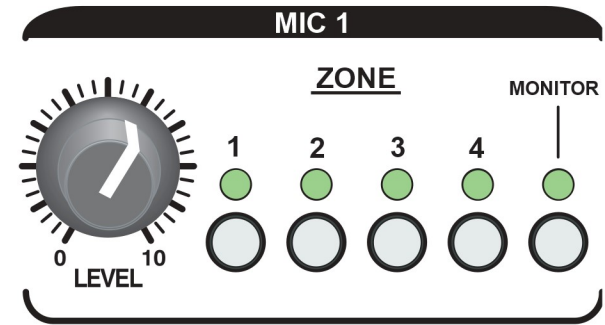

The front panel LEVEL and ZONE switches are the same for all channels. Simply activate the appropriate switches to send that channels information to the required output zone.



The output XLR's 1-4 are line level balanced outputs.

Q: I am getting distortion out of all of the XLR outputs and the level is very high?

A: You are plugging the line level outputs into something that is MIC level. You will always get distortion and excessive volume. The RM424 is only designed to have a LINE LEVEL output not MIC LEVEL.



The slotted holes in the back of the RM424 are for the attachment of a wire tie (included on the PS27s cord) or a small zip tie (not included), for power cord strain relief as needed. Just thread the tie thru the holes and attach the cord.

The front panel LEVEL and ZONE switches are the same for all channels. Simply activate the appropriate switches to send that channels information to the required output zone.

The MONITOR section of the RM424 is designed to be able to monitor a signal before it is sent to a zone.

The MASTER VOLUME controls on the front of the RM424 function just as the name implies.

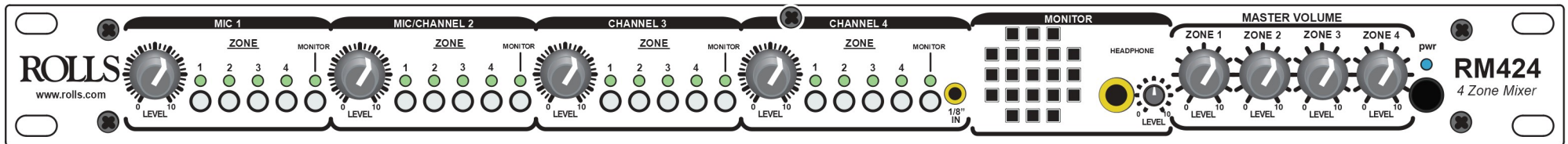

PHANTOM POWER and Talk Over Zone Assignment, See page 5 of this manual.

The output XLR's 1-4 are line level balanced outputs.

MIC 1 XLR input switchable mic or line level.

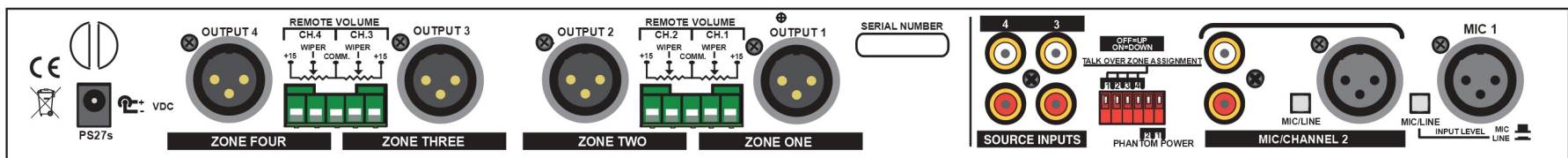

The remote volume section on the back of the RM424 is designed to enable the installer the ability to install remote volume controls for the various zones of the RM424. Follow the silk screening of the unit for exact channel information.

Channel 3 and 4 inputs are line level RCA's.

MIC/CANNEL 2 is a single input channel that can be XLR input or an RCA input.