

Leon Studio Frame for Sony BRAVIA 7

Installation Instructions

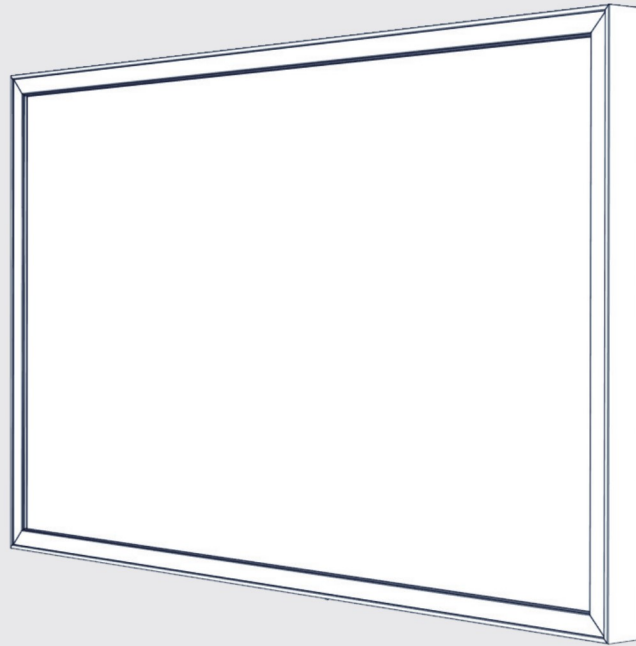

Before Installation

⚠ Mitered corners on your frame can be sharp. Handle with care.

- Please install and/or uninstall the frame with 2 or more people.
- Always remove frame first before removing display from the wall bracket
- Do not apply force to the screen of your display
- Choose an installation location free of physical obstructions behind or within the wall





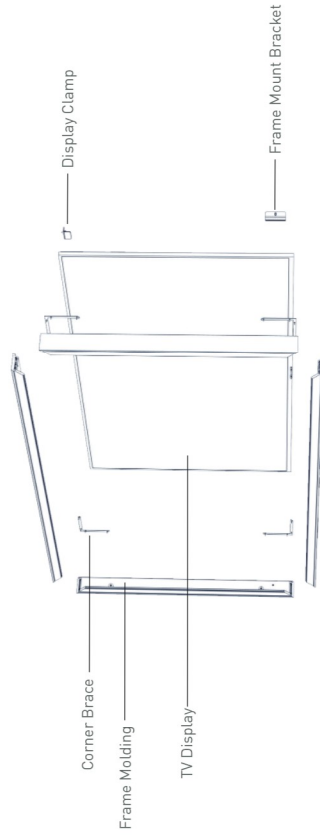



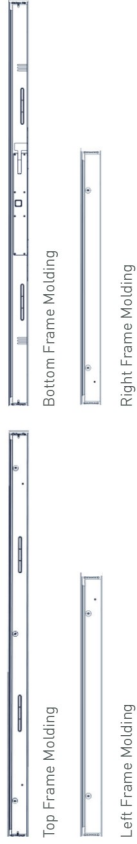

Estimated frame assembly time 15-20 minutes. Estimated app installation time 5-10 minutes.

NOTE: To gain full functionality of your Sony remote control, you will need to add an IR repeater to your installation.



What's Included



 A x16 #6-1/2" Phillips Screw	 B x4 Corner Brace	 C x2 Display Clamp	 D x2 Frame Mount Bracket	 E x4 M5 Thumb Screw
 F x1 Sensor-USB Cable	 G x2 VESA Herm Bar	 H App Installation USB Drive	 I IR Repeater	 J 4mm Hex Key

Tools Required



Step 1. Prepare Your Working Area and Unbox the Frame

Designate a clean, level, non-abrasive surface free from debris and large enough to accommodate your frame assembly.

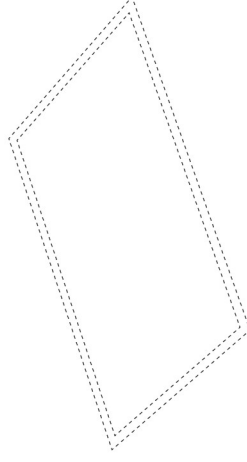

Step 2. Install Wall Mount Bracket and Mount TV to the Wall

Install the wall mount bracket [SU-WL905 bracket recommended, not provided by Leon] and mount the TV to the wall. Be sure to follow SU-WL905 bracket installation instructions to mount your TV.

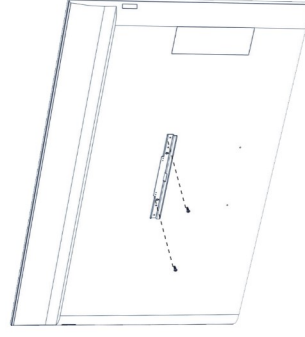

Step 3. Lay Out Frame

On your clean and level surface, begin frame assembly by lining up all 4 frame moldings face down. Match the corresponding corners using the symbols indicated on the moldings.

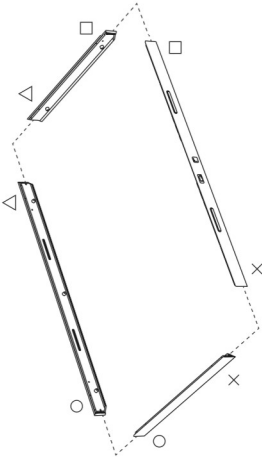

TIP Avoid assembling the frame on carpet, as it may cause uneven alignment during assembly. Use the included foam sheets to protect the frame's finish.

Step 4a. Join Frame Corners

Begin attaching frame corners by interlocking the Cam Lock connectors. While holding two frame corners together, locate the hex head in the access pocket on the inside of the frame and hand-tighten using the hex key provided [J].



TIP If the hex head adjustment screw is not centered in the access pocket, slide the Cam Lock until the hex head is properly positioned. Then insert hex key into the hex head to keep it centered **BEFORE** joining corners.

Step 4b. Ensure Frame Corners are Flush

Make final adjustments to eliminate any gaps before assembling the other frame corners. Take care to ensure that the front face is **FLUSH**.

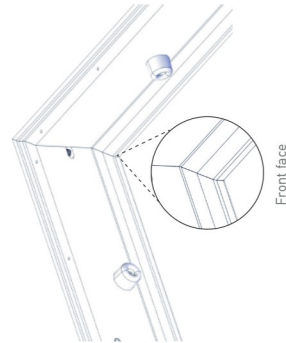

Step 5. Install Corner Braces

Fasten Corner Braces [B] with the provided #6 x 1/2" screws [A] at each of the four corners, hand-tightening using a Phillips head screwdriver.

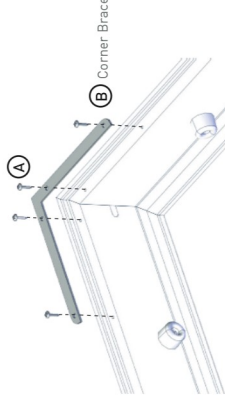

TIP Attach the corner brace to **ONE** frame molding piece. Position the second frame molding piece, keeping the front face aligned flush. Hold frame flush and screw in the other side of the corner brace to secure the assembly.

Step 6. Attach Display Clamps to Top of Frame

Attach 2 Display Clamps [C] to the Top Frame Molding using the provided M5 Thumb Screws [E]. Leave loose for adjustment later.

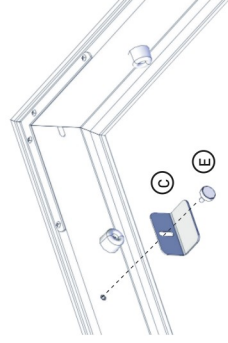

Step 7. Connect Sensor USB Cable

Connect the micro-USB end of the Sensor USB Cable [F] to the sensor input on the bottom of the assembled frame. This will enable the motion and light sensors for the Sony Art Frame Gallery App. The loose end of the cable will connect to the TV after the frame is attached.

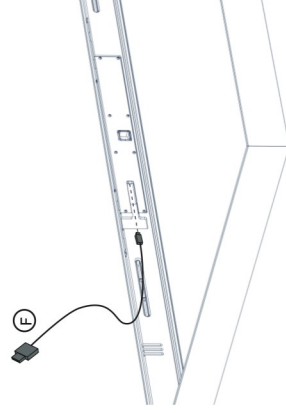

▲ Insert micro-USB gently

NOTE: USB symbol on the cable end should be facing up when connecting to the sensor input

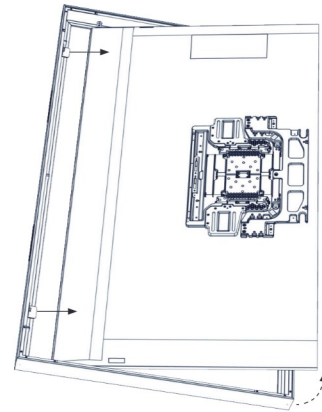

Step 8. Place Frame Around TV Display

With the TV fully articulated off the wall, place frame around TV by hooking the Display Clamps (C) over the top of the display and seating the frame down around the bottom of the TV.

Keep the TV fully articulated until installation is complete.

NOTE: Use care to ensure the rubber bumpers along the frame interior rest along the TV perimeter, floating the frame around the TV.

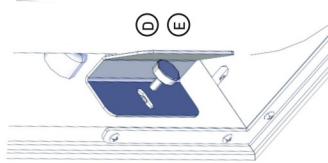

Step 9.

Fasten Frame Mount Brackets

Fasten the Frame Mount Brackets (D) to the sides of the frame using the M5 Thumb Screws (E). Adjust and tighten Display Clamps and Frame Mount Brackets to ensure the frame is properly positioned around the TV display.

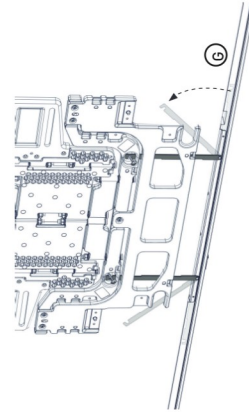

Step 10. Fasten VESA Hem Bars to Bottom VESA Screws

Loosen the two bottom M6 screws attaching the SU-WL905 to the TV display. Rotate the VESA Hem Bars located along the bottom of the frame inward to hook behind the head of the screws. Re-tighten screws.

NOTE: You may need to articulate the TV off the wall in order to reach the components in these next steps.

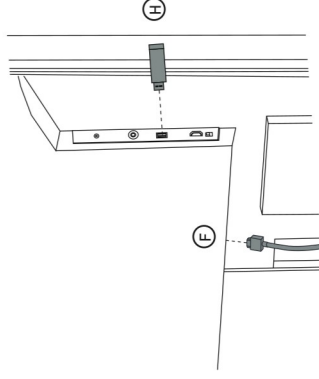

Step 11. Connect USB Cable & App Installation USB Drive

Route Sensor USB Cable (F) through channel in the back of the display to the USB port in the bottom of the TV. Gather cable slack and neatly tuck into TV's cable management area. Plug the App Installation USB Drive (H) into the USB port on the side of the display. The Studio Frame installation is now complete!

NOTE: Follow app installation guide to install Sony Art Frame Gallery App and Artwork.



Recommended location of IR Repeater

Step 12. Connect IR Repeater to TV (Optional)

After installing Sony Art Frame Gallery App and Artwork and removing the App Installation USB Drive (H), install USB end of IR Repeater (I) into the vacant USB port on the back of the TV. Insert the 3.5mm audio jack into the IR IN on the back of the TV. Peel back the adhesive and place the IR Repeater on the bottom of the frame at the recommended location.

TIP: Place IR Repeater towards the back of the frame to remove from sight



Scan the QR Code for Warranty

Questions?

For additional support, call customer service
1 (888) 213-5015 | Mon - Fri 9:00 am-6:00 pm EST



Leon is a registered trademark of Leon Speakers, Inc ©2024.

REF-25-132_Studio_Frame_20240226